

SERVICE MANUAL

ON/OFF

Wall mounted Type ARC-Series



HSU-22L/HEA03



22K

Haier
Inspired living



Большая библиотека технической документации

<https://splitsystema48.ru/instrukcii-po-ekspluatacii-kondicionerov.html>

каталоги, инструкции, сервисные мануалы, схемы.

Table of Contents

1. Introduction	1
2. List of Functions	6
3. Specifications	7
4. Printed Circuit Board Connector Wiring Diagram	9
5. Functions and Control	10
5.1 main functions and control specifications.....	10
5.2 Value of Thermistor..	15
6. System Configuration	23
6.1 System Configuration.....	23
6.2 Instruction.....	23
7. Error Codes and Description	47
7.1 Problem Symptoms and Measures	47
7.2 TroubleShooting.....	48
8. Installations	50
9. Removal Procedure	58
9.1 Removal of Air Filter.....	58
9.2 Removal of Front Grille.....	59
9.3 Removal of Horizontal Blade	60

9.4 Removal of Drain pan	63
9.5 Removal of Vertical Blades and Swing Motor.....	65
9.6 Removal of Electrical Box	65
9.7 Removal of Heat Exchanger.....	66
9.8 Removal of Fan Rotor and Fan Motor.	68
9.9 Removal of Outdoor Panel	70
9.10 Removal of Electrical Box	74
9.11 Removal of Outdoor panel	75
9.12 Removal of fan motor bractek and parttion	76
9.13 Removal of compressor and heat exchanger.....	78
10. Appendix.....	80
10.1 Piping Diagrams.....	80
10.2 Wiring Diagrams.....	81
10.3 Circuit Diagrams.....	83

1. Introduction

1.1 Safety Cautions

Be sure to read the following safety cautions before conducting repair work.

The caution items are classified into “Warning” and “Caution”. The “Warning” items are especially important since they can lead to death or serious injury if they are not followed closely. The “Caution” items can also lead to serious accidents under some conditions if they are not followed. Therefore, be sure to observe all the safety caution items described below.

About the pictograms

△ This symbol indicates an item for which caution must be exercised.

The pictogram shows the item to which attention must be paid.

○ This symbol indicates a prohibited action.





The prohibited item or action is shown inside or near the symbol.





● This symbol indicates an action that must be taken, or an instruction.

The instruction is shown inside or near the symbol.

After the repair work is complete, be sure to conduct a test operation to ensure that the equipment operates normally, and explain the cautions for operating the product to the customer.

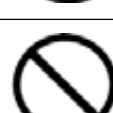
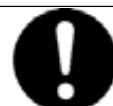

1.1.1 Caution in Repair

Warning	
<p>Be sure to disconnect the power cable plug from the plug socket before disassembling the equipment for a repair.</p> <p>Working on the equipment that is connected to a power supply can cause an electrical shock.</p> <p>If it is necessary to supply power to the equipment to conduct the repair or inspecting the circuits, do not touch any electrically charged sections of the equipment.</p>	
<p>If the refrigerant gas discharges during the repair work, do not touch the discharging refrigerant gas. The refrigerant gas can cause frostbite.</p>	
<p>When disconnecting the suction or discharge pipe of the compressor at the welded section, release the refrigerant gas completely at a well-ventilated place first.</p> <p>If there is a gas remaining inside the compressor, the refrigerant gas or refrigerating machine oil discharges when the pipe is disconnected, and it can cause injury.</p>	
<p>If the refrigerant gas leaks during the repair work, ventilate the area. The refrigerant gas can generate toxic gases when it contacts flames.</p>	
<p>The step-up capacitor supplies high-voltage electricity to the electrical components of the outdoor unit.</p> <p>Be sure to discharge the capacitor completely before conducting repair work. A charged capacitor can cause an electrical shock.</p>	
<p>Do not start or stop the air conditioner operation by plugging or unplugging the power cable plug.</p> <p>Plugging or unplugging the power cable plug to operate the equipment can cause an electrical shock or fire.</p>	

Warning	
Do not repair the electrical components with wet hands. Working on the equipment with wet hands can cause an electrical shock.	
Do not clean the air conditioner by splashing water. Washing the unit with water can cause an electrical shock.	
Be sure to provide the grounding when repairing the equipment in a humid or wet place, to avoid electrical shocks.	
Be sure to turn off the power switch and unplug the power cable when cleaning the equipment. The internal fan rotates at a high speed, and cause injury.	
Do not tilt the unit when removing it. The water inside the unit can spill and wet the furniture and floor.	
Be sure to check that the refrigerating cycle section has cooled down sufficiently before conducting repair work. Working on the unit when the refrigerating cycle section is hot can cause burns.	
Use the welder in a well-ventilated place. Using the welder in an enclosed room can cause oxygen deficiency.	



1.1.2 Cautions Regarding Products after Repair

Warning	
Be sure to use parts listed in the service parts list of the applicable model and appropriate tools to conduct repair work. Never attempt to modify the equipment. The use of inappropriate parts or tools can cause an electrical shock, excessive heat generation or fire.	
When relocating the equipment, make sure that the new installation site has sufficient strength to withstand the weight of the equipment. If the installation site does not have sufficient strength and if the installation work is not conducted securely, the equipment can fall and cause injury.	
Be sure to install the product correctly by using the provided standard installation frame. Incorrect use of the installation frame and improper installation can cause the equipment to fall, resulting in injury.	For integral units only
Be sure to install the product securely in the installation frame mounted on a window frame. If the unit is not securely mounted, it can fall and cause injury.	For integral units only

Warning	
<p>Be sure to use an exclusive power circuit for the equipment, and follow the technical standards related to the electrical equipment, the internal wiring regulations and the instruction manual for installation when conducting electrical work.</p> <p>Insufficient power circuit capacity and improper electrical work can cause an electrical shock or fire.</p>	
<p>Be sure to use the specified cable to connect between the indoor and outdoor units. Make the connections securely and route the cable properly so that there is no force pulling the cable at the connection terminals.</p> <p>Improper connections can cause excessive heat generation or fire.</p>	
<p>When connecting the cable between the indoor and outdoor units, make sure that the terminal cover does not lift off or dismount because of the cable.</p> <p>If the cover is not mounted properly, the terminal connection section can cause an electrical shock, excessive heat generation or fire.</p>	
<p>Do not damage or modify the power cable.</p> <p>Damaged or modified power cable can cause an electrical shock or fire. Placing heavy items on the power cable, and heating or pulling the power cable can damage the cable.</p>	
<p>Do not mix air or gas other than the specified refrigerant (R-410A / R22) in the refrigerant system.</p> <p>If air enters the refrigerating system, an excessively high pressure results, causing equipment damage and injury.</p>	
<p>If the refrigerant gas leaks, be sure to locate the leak and repair it before charging the refrigerant. After charging refrigerant, make sure that there is no refrigerant leak.</p> <p>If the leak cannot be located and the repair work must be stopped, be sure to perform pump-down and close the service valve, to prevent the refrigerant gas from leaking into the room. The refrigerant gas itself is harmless, but it can generate toxic gases when it contacts flames, such as fan and other heaters, stoves and ranges.</p>	
<p>When replacing the coin battery in the remote controller, be sure to disposed of the old battery to prevent children from swallowing it.</p> <p>If a child swallows the coin battery, see a doctor immediately.</p>	

Caution	
<p>Installation of a leakage breaker is necessary in some cases depending on the conditions of the installation site, to prevent electrical shocks.</p>	
<p>Do not install the equipment in a place where there is a possibility of combustible gas leaks.</p> <p>If a combustible gas leaks and remains around the unit, it can cause a fire.</p>	
<p>Be sure to install the packing and seal on the installation frame properly. If the packing and seal are not installed properly, water can enter the room and wet the furniture and floor.</p>	For integral units only

1.1.3 Inspection after Repair

Warning	
<p>Check to make sure that the power cable plug is not dirty or loose, then insert the plug into a power outlet all the way.</p> <p>If the plug has dust or loose connection, it can cause an electrical shock or fire.</p>	
<p>If the power cable and lead wires have scratches or deteriorated, be sure to replace them.</p> <p>Damaged cable and wires can cause an electrical shock, excessive heat generation or fire.</p>	





Warning	
<p>Do not use a joined power cable or extension cable, or share the same power outlet with other electrical appliances, since it can cause an electrical shock, excessive heat generation or fire.</p>	

Caution	
<p>Check to see if the parts and wires are mounted and connected properly, and if the connections at the soldered or crimped terminals are secure. Improper installation and connections can cause excessive heat generation, fire or an electrical shock.</p>	
<p>If the installation platform or frame has corroded, replace it. Corroded installation platform or frame can cause the unit to fall, resulting in injury.</p>	
<p>Check the grounding, and repair it if the equipment is not properly grounded. Improper grounding can cause an electrical shock.</p>	
<p>Be sure to measure the insulation resistance after the repair, and make sure that the resistance is 1 M ohm or higher.</p> <p>Faulty insulation can cause an electrical shock.</p>	
<p>Be sure to check the drainage of the indoor unit after the repair.</p> <p>Faulty drainage can cause the water to enter the room and wet the furniture and floor.</p>	

1.1.4 Using Icons

Icons are used to attract the attention of the reader to specific information. The meaning of each icon is described in the table below:

1.1.5 Using Icons List

Icon	Type of Information	Description
 Note:	Note	A “note” provides information that is not indispensable, but may nevertheless be valuable to the reader, such as tips and tricks.
 Caution	Caution	A “caution” is used when there is danger that the reader, through incorrect manipulation, may damage equipment, lose data, get an unexpected result or has to restart (part of) a procedure.
 Warning	Warning	A “warning” is used when there is danger of personal injury.
	Reference	A “reference” guides the reader to other places in this binder or in this manual, where he/she will find additional information on a specific topic.

2. List of Functions

Category	Functions	HSU-22LEA03	HSU-22HEA03
Healthy negative ion	make your room full of an abundance natural negative ions.	Y	Y
Child lock	Avoid the child's wrong operation on the remote controller	Y	Y
3D air flow	The 3D airflow is able to deliver the airflow horizontally and vertically.	N	N
24Hour timer	Use the timer function to set on,or off,or from on to off,or from off to on	Y	Y
Auto restart	automatic return to previous operation conditions after asudden power blackout	Y	Y
Easy clean design	The panel is easy to wash and the airflow vents can be detached easily	Y	Y
Intelligent air	With twin-blade technology ,the airflow can be adjusted not to blow directly	Y	Y
Anti-mold filter	Catches most small particles and remove unpleasant odors effectively.	Y	Y
Sleep mode	The setting temprature and the indoor noise can be adjusted to a more comfortable level when you set the "sleep mode"during night sleep	Y	Y
4 Fan setting	Slect the fan speed LO,MED,HI,AUTO	Y	Y
Auto mode	adjust the last fixed operation mode automatically.	Y	Y
Power mode	Quick cooling or heating	N	N
Soft mode	lower noise operation condition	Y	Y
Negative ion filter	Generate negative ions by the filter.	Y	Y
Constant temperature dehumidification	Make dehumidifying in the room while keeping the constant temperature inside	N	N

Note: Y: Holding Functions

N : No Functions

3. Specifications

Model			HSU-22LEA03		HSU-22HEA03	
			Cooling	Heating	Cooling	Heating
Capacity Rated	kW		6.0	---	6.0	6.7
	Btu/h		20450	---	20450	22850
Moisture Removal	L/h		2.5	---	2.5	2.5
Running Current (Rated)	A		11.0	---	11.0	11.8
Power Consumption Rated	W		2250	---	2300	2450
EER/COP	W/W		2.67	---	2.67	2.61
Piping Connections (external diameter)	Liquid	mm	Φ 9.52		Φ 9.52	
	Gas	mm	Φ 15.88		Φ 15.88	
	Drain	mm	Φ 16		Φ 16	
Heat Insulation			Both Liquid and Gas Pipes		Both Liquid and Gas Pipes	
Max. Piping Length	m		15		15	
Max. Level Difference	m		5		5	
Chargeless	m		10		10	
Amount of Additional Charge of Refrigerant	g/m		60		60	
Indoor Unit						
Front Panel Color			white		white	
Air Flow Rate	m ³ /min(cfm)	H	13.7(482.2)	---	13.7(482.2)	13.7(482.2)
		M	12.4(436.5)	---	12.4(436.5)	12.0(422.4)
		L	11.1(390.7)	---	11.1(390.7)	10.2(359.0)
Fan	Type		Cross Flow Fan		Cross Flow Fan	
	Motor Output	W	40		40	
	Speed	Steps	5 Steps, Silent, Auto		5 Steps, Silent, Auto	
Air Direction Control			Right, Left, Horizontal, Downward			
Air Filter			Removable / Washable / Mildew Proof			
Run current (rated)	A		0.65	---	0.65	0.65
Power consumption	W		40	---	40	40
Temperature Control			Microcomputer Control		Microcomputer Control	
Dimensions (WxHxD)	mm		938x182x265		938x182x265	
Packaged Dimensions (WxHxD)	mm		1009x277x339		1009x277x339	
Weight	kg		10.5		10.5	
Gross Weight	kg		12.5		12.5	
Operation Sound	H/M/L	dBA	50/46/40	---	50/46/40	50/46/42
Sound Power	H(cooling/heating)	dBA	60	---	60	60

Outdoor Unit						
Casing Color		White		White		
Compressor	Type		Rotary compressor		Rotary compressor	
	Model		PH400X3CS-8KUC1		PH420X3CS-8KUC1	
	Motor Output	W	2245		2370	
	Oil Type		SUNISO 4GSI		SUNISO 4GSI	
	Oil Charge	L	0.95		0.95	
Refrigerant	Model		R22		R22	
	Charge	kg	1.48		2.02	
Air Flow Rate (H)	m ³ /min		7.8	---	7.8	7.8
	cfm		1267.2	---	1267.2	1267.2
Fan	Type		Axial fan		Axial fan	
	Motor Output	W	37		37	
Runing current (rated)		A	10.35	---	10.35	11.15
Power Consumption (rated)		W	2210	---	1900	2410
Dimensions (H×W×D) (stop valve, and bottom support is not included)		mm	810x288x680		810x288x680	
Packaged Dimensions (H×W×D)		mm	946x425x755		946x425x755	
Weight		kg	52		57	
Gross Weight		kg	56		62	
OperationSound	H	dBA	56	---	56	56
Sound Power	H(cooling/heating)	dBA	66	---	66	66

Note: The data are based on the conditions shown in the table below.

Cooling	Heating	Piping Length
Indoor: 27°CDB/19°CWB Outdoor: 35°CDB/24°CWB	Indoor: 20°CDB Outdoor: 7°CDB/6°CWB	7.5m

Conversion Formulae
kcal/h=kW×860
Btu/h=kW×3414
cfm=m ³ /min×35.3

4. Printed Circuit Board Connector Wiring Diagram

Indoor unit

Connectors Indoor PCB

- 1)CN601 connector for DC fan motor.
- 2)CN602 connector for power line.
- 3)CN604 connector for ambient temp. sensor and piping temp.sensor.
- 4)CN5" connector for up and down step motor.
- 5)CN701 connector for receiver display.

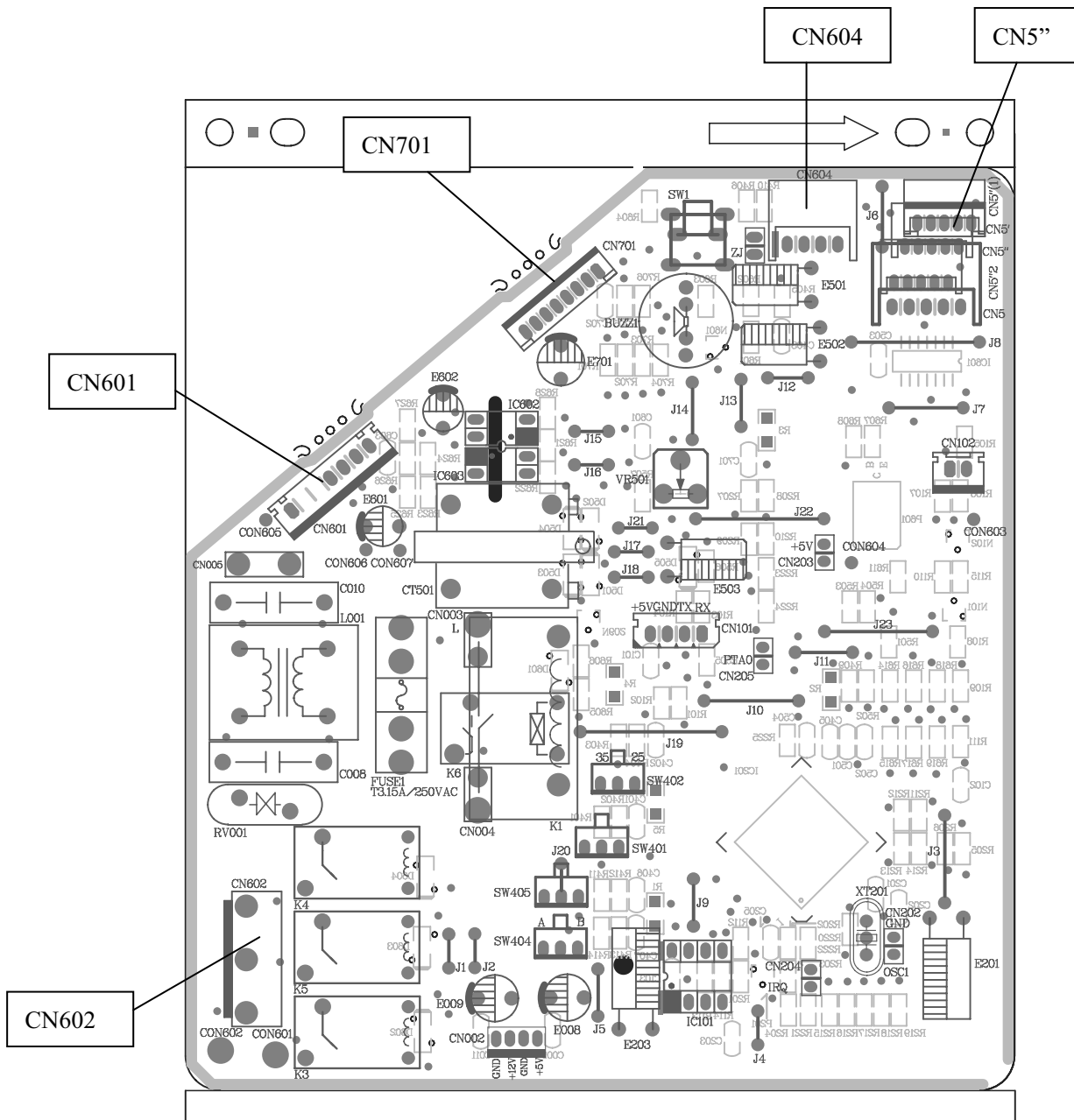

5 Functions and control

5.1 main functions and control specifications

Including brief introduction to air conditioners of series models and electric control function.

5.1.1 Automatic running

(1) Automatic running mode

When the running mode is turned to automation after starting the system, the system will first determine the running mode according to the current room temperature and then will run according to the determined mode. Tr in the following selection conditions means room temperature, Ts means setting temperature, Tp means temperature of indoor coil pipe

- a. $Tr \geq 23^{\circ}\text{C}$ running cooling mode
- b. $Tr < 23^{\circ}\text{C}$ running heating mode

After turning to the automation mode, the running mode can be switched between cooling mode, fan mode and heating mode according to the change of the indoor ambient temperature. But the automatic conversion between cooling mode and heating mode must be conducted after 15 minutes.

(2) Single cold automatic run mode:

After entering into this mode, the main control “MCU” determines the corresponding work pattern according to the indoor temperature so as to maintain the preset temperature (the preset temperature is 26°C). When the indoor temperature is below 26°C , outlet air from compressor is off, the automatic wind from fan motor is low, and wind can be set to high, medium or low by hand. When the indoor temperature is or above 26°C , the unit enters the cooling mode and conducts the cooling programme (the preset temperature is 26°C), outlet air from compressor is on and indoor fan motor run in fixed wind speed.

5.1.2 Indoor temperature control

Temperature control range : $16^{\circ}\text{C}—30^{\circ}\text{C}$

Temperature control precision: $\pm 1^{\circ}\text{C}$

Compressor can't be controlled by temperature sensor within 2 minutes after it starts

① Cooling mode:

When $Tr > Ts$, outdoor fan motor and compressor on, and indoor fan motor run at fixed wind speed. When $Tr < Ts$, outdoor fan motor and compressor off, and when $Tr > Ts$, outdoor fan motor and compressor are working again .If $Tr = Ts$, the indoor fan motor , outdoor fan motor and the compressor's state will not change.

② Heating mode:

When $Tr \leq Ts$, compressor, four-ways valve and outdoor fan motor is on, indoor fan motor runs as in cold blast avoidance mode, and 4°C of compensation is added after compressor is started.

When $Tr > Ts + 5^{\circ}\text{C}$, compressor is off, and the indoor fan motor runs as in cold blast avoidance mode.

When $Tr < Ts + 5^{\circ}\text{C}$, compressor, four-ways valve and outdoor fan motor is on, and the indoor fan motor runs as in the mode of avoiding cold blast.

5.1.3 Cooling run mode:

temperature control range : $16^{\circ}\text{C}—30^{\circ}\text{C}$

temperature control precision: $\pm 1^{\circ}\text{C}$

compressor can't be controlled by temperature sensor within 2 minutes after it starts.

control character: when $Tr \geq Ts$, outlet air from compressor is on and indoor fan motor run at fixed wind speed. When $Tr < Ts$, outlet air from compressor is off , and when $Tr > Ts$, outlet air from compressor is on.

wind speed control: (the temperature difference is 1°C)

auto: when $Tr \geq Ts + 3^{\circ}\text{C}$, the wind speed is high;

When $Ts + 1^{\circ}\text{C} \leq Tr < Ts + 3^{\circ}\text{C}$, the wind speed is medium.

When $Tr < Ts + 1^{\circ}\text{C}$, the wind speed is low.

When temperature sensor is off, the fan motor runs at low speed.

when the wind speed changes from low to high, there is no delay, and when it changes from high to low, there is a 3-minutes delay before conversion.

Manual operation: When unit is on the wind speed can be set to high, medium, low or automatic as required (execute instruction 2 seconds later after receiving remote signal)

Compressor control: The compressor can't be controlled by temperature sensor within 2 minutes after start up and can be only restarted at least 3 minutes later after shutdown. There is no 3-minute protection with power on for the first time (over 3 minutes with power off). The compressor must stand by for 3 minutes before it is restarted after shut down.

There is no 2-minute limit when changing the temperature setting or shutting down the machine through the remote controller, and the machine can be shut down immediately.

Avoiding electrical shock: outlet air is available 2 seconds later after startup.

High temperature expiration protection:

(1) High temperature expiration prevention: When the temp. of coil pipe is above 64°C , compressor and outlet air stop running 10 seconds later, and inlet air runs as the temp. sensor is off. When compressor stands by for 3 minutes and the temp. of coil pipe is below 60°C , the unit can be started again.

Protection of frost is available (disable in test run or heating mode): In order to prevent the indoor heat exchanger from freezing (in refrigeration or dehumidifying mode), the compressor will be shut off when the temperature of the indoor coil pipe is or below 0°C and the compressor runs for over 5 minutes. When the temperature of the indoor coil pipe ascends to over 7°C , the compressor is restarted (must meet a 3-minutes delay)

Timer on, Timer off and sleep control are available.

5.1.4 Dehumidifying mode:

Temperature control range : $16^{\circ}\text{C} - 30^{\circ}\text{C}$

Control character:

When Tr (indoor temperature) $> Ts$ (temperature setting) $+ 2^{\circ}\text{C}$, compressor and outdoor fan motor run continuously with indoor fan motor running in accordance with the wind speed setting (State 1).

When $Ts \leq Tr \leq Ts + 2^{\circ}\text{C}$, outlet air from compressor is on for 10 minutes and off for 6 minutes, the indoor fan motor is off in 3 minutes after shut down of compressor and gives breeze in other time (State 2).

When $Tr < Ts$, outlet air from compressor is unavailable, and the indoor fan motor enter breeze mode 3 minutes later after shut down of compressor (State 3).

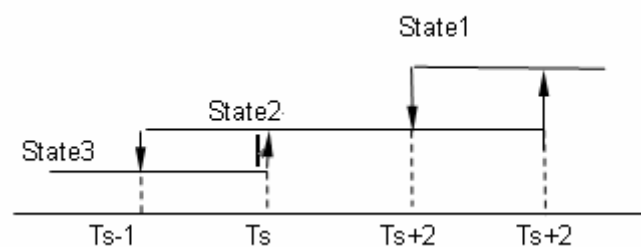

When all the ranges alternate, there is $\pm 1^{\circ}\text{C}$ difference.

5.1.5 Heating mode: (cooling only have no the mode)

*Temperature control range : 16°C —30°C

*Temperature control precision: ±1°C

*Control Character:

When $T_r \leq T_s$, compressor, four-ways valve and outdoor fan motor is on, indoor fan motor runs as in cold blast mode, and 4°C of compensation is added after compressor is started.

When $T_r > T_s + 5^\circ\text{C}$, compressor is off, and the indoor fan motor runs as in warm blast mode.

When $T_r < T_s + 5^\circ\text{C}$, compressor, four-ways valve and outdoor fan motor is on, and the indoor fan motor runs as in the mode of avoiding cold blast.

*Control of indoor fan motor:

Manual operation: The wind speed can be set to high, medium, low or automatic as required.

Automatic operation: When $T_r < T_s$, the wind speed is high;

When $T_s \leq T_r < T_s + 2^\circ\text{C}$, the wind speed is medium.

When $T_s + 2^\circ\text{C} \leq T_r$, the wind speed is low.

*Control of air door: setting the position of air door as required.

*Compressor control: The compressor can't be controlled by temperature sensor in 2 minutes after start up and also can't be started again at least 3 minutes later after shut down. There are 3-minute protection with power on for the first time (over 3 minutes with power off). The compressor must be started again 3 minutes later after shut down.

*Avoiding electrical shock: outlet air is available 2 seconds later after start up.

*Timer on, Timer off and sleep control are available.

*Control of 4-way valve: When the unit is started for the first time, the 4-way valve starts running 10 seconds earlier than compressor does. After compressor stops running, the 4-way valve continues running for 2 minutes and then stops. If changing the unit from heating to cooling, the 4-way valve is shut off 2 minutes later and compressor is started 3 minutes later.

***Cold draft prevention:**

(1) Compressor is interrupted during the defrosting operation and continues to run after defrosting is completed. When the indoor exchanging temperature is below 23°C, the indoor fan motor is off. When the indoor exchanging temperature is above 23°C, the indoor fan motor is running at weak speed.

(2) If the temperature of coil pipe can't be above 38°C 4 minutes later after start up, fan motor is running at the preset wind speed.

(3) If the temperature of coil pipe is above 38°C 4 minutes later after start up, fan motor is running at the preset wind speed.

(4) If coil pipe descends to the temp. lower than 38°C from 38°C. fan motor is running at the preset wind speed.

*Warm blast: If the temperature sensor is off. Compressor stops running. If the temperature of coil pipe is above 23°C, fan motor enter breeze mode; and if the temperature of coil pipe is below 20°C, fan motor stops running.

***High temperature protection and high temperature expiration protection:**

(1) High temperature prevention: When the temp. of coil pipe is above 65°C, the outdoor fan motor stops. When the temp descends to 60°C, the outdoor fan motor is restarted and fan speed invertage frequency is more than 45 seconds.

(2) High temperature expiration prevention: When the temp. of coil pipe is above 72°C, compressor and outlet air stop running 10 seconds later, and inlet air runs as the temp. sensor is off. When compressor stands by for 3 minute and the temp. of coil pipe is below 64°C, the unit can be started again.

*Current protection and current expiration protection: (Not detecting within 60 seconds after start up)

*Overcooling protection: One and half a minutes later after compressor starts, if the temperature of coil pipe

is below -4°C , compressor and air outlet stop, and air inlet runs according to the temp. setting. Compressor can be restarted 3 minutes later.

*Defrosting:

1.Entry conditions of defrosting:

The entry conditions of defrosting is classified into two types: intelligentized defrosting and sensor defrosting. Through selecting and judging, the models without outdoor sensor defrosts according to intelligentized defrosting, and others with ensor defrosts according to sensor defrosting.

Intelligentized defrosting:

A.Indoor unit enter overload protection and air outlet stops when air outlet has been restarted and runs over 10 minutes, and compressor runs over 45 minutes in total and over 20 minutes continuously, and the temp. of indoor coil pipe is below 42°C .

B.Compressor runs 20 minutes continuously, and the temp. of indoor coil pipe decreases 1°C per 6 minutes and this operation repeats 3 times, and the temp. of coil pipe is below 42°C , and 5 minutes later after compressor is restarted.

C.When compressor runs over 3 hours in total and over 20 minutes continuously and after the temp. of indoor coil pipe is below 42°C , the system enters defrosting mode.

D.The difference between the temp. of indoor coil pipe and the indoot temp. is below 18°C and lasts 5 minutes, compressor runs over 45 minutes in total and over 20 minutes continuously after the temp. of indoor coil pipe is below 42°C , the system enters defrosting mode.

2.Exit conditions of defrosting:

Defrosting time is higher than 12 minutes (compressor is on).

①During the defrosting, if current peak value is cut off, the unit quit the defrosting mode. But the protection of expiration of current peak value is unavailable with 60 seconds after compressor is started.

②During the defrosting and 2 minutes After quitting the defrosting mode, abnormality of temp. sensor isn't detected.

③After quitting the defrosting mode, the fan motor enter cooling prevention mode.

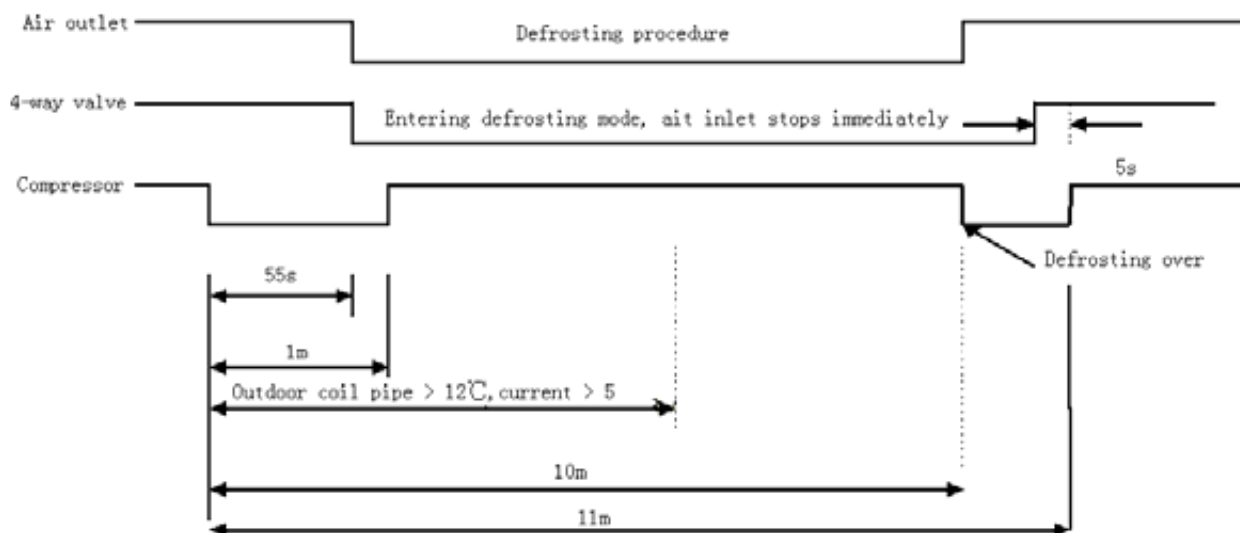

5.1.6 Timer function:

You can set 24-hour timer on or timer off as required, and the minum time unit is 1 minute. After setting, the indicator of indoor unit is on , and it is off when timer setting is completed. There are several timer mode as follows.

(1)Timer on: The LED of “timer on” lights up, and unit behaves with halt status. Timer on is completed,

and then unit starts running with the LED of “timer on” off. The unit starts with the the last setting receiving timer signals, and sleep setting is not allowed.

(2)Timer off: Unit starts, timer indicator lights up; When reaching time setting, the indicator goes out, unit enters shut down mode, and sleep function can be set. If timer off and sleep are set synchronously, the one which time is short run first. Executing shutdown instruction clear timer and sleep function.

(3)Timer on and timer off can be set synchronously.

5.1.7 Sleep function: the timer indicator lights up.

(1)In cooling/defrosting mode, the temp. setting increases 1°C one hour later after start up. After another hour the temp. setting increase by more 1°C and then run continuously for another 6 hours and then close.

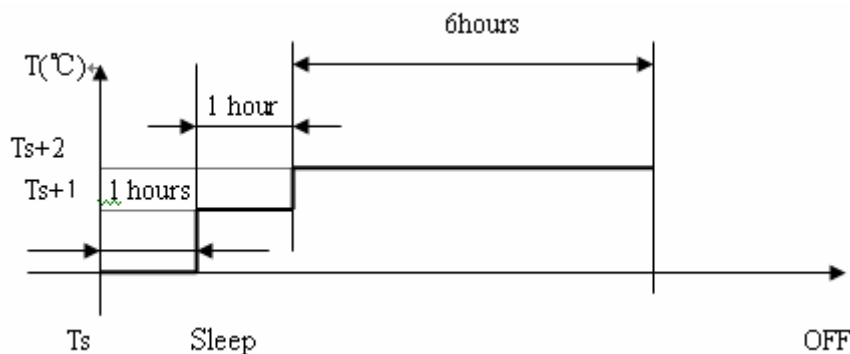

(2)In heating mode, the temp. setting decrease 2°C one hour after start up. After another hour the temp. setting decrease by more 2°C . After 3 hours the temp. setting rise by 1°C and then run continuously for another 3 hours and then close.

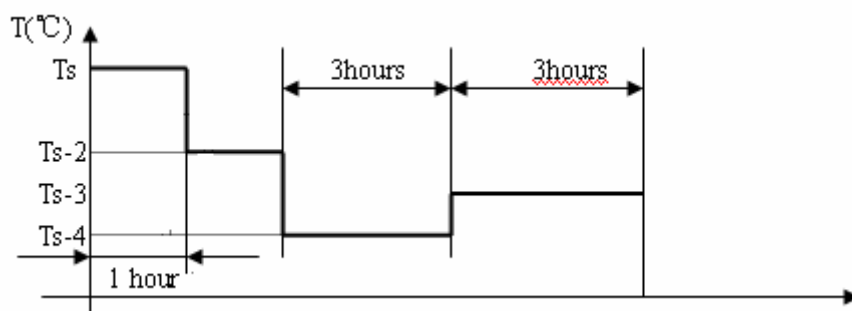

(3)If the wind speed is set to high before going to bed, the wind speed become medium after start up; If the wind speed is set to medium before going to bed, the wind speed become low after start up; If the wind speed is set to low before going to bed, the wind speed keep unchanged.

5.1.8 Emergency switch input:

(1)Press the switch of emergency operation, then buzzer rings once and unit enters the automatic operation mode. (emergency operation)

(2)If the switch is kept pressed for 5 seconds, buzzer ring two times and unit enter enter test run mode.

(3)Press the switch again, and then closes.

(4)Enter emergency operation from timer mode, then timer is cancelled.

5.1.9 Test run:

(1)The temperature sensor of inlet air doesn't work, and compressor starts (but subject to the limit of -minute delay excluding the first time), and high wind, cooling, and air door is open. The indoor fan motor runs, running indicator lights up, compressor relay and the one of outdoor fan motor is closed

(2)During test run:

The prevention of freezing of evaporator doesn't work.

Current cross control doesn't work.

The control of current cross peak expiration doesn't work.

Temperature control doesn't work.

Temperature expiration control doesn't work.

5.1.10 The memory function of power down is available, and the auto recovery function of power on is optional. (In auto, heating, cooling, or defrosting status, press the "sleeping" button 10 times within 5 seconds, and the auto recovery function of power on can be set on/off. If the buzzer rings 4 times, the the auto recovery function of power on is available; If the buzzer rings 2 times, the the auto recovery function of power on is unavailable.)

If there is no EEPROM, the unit is taken off the 'off' function of the memory function of power down. But the memory function of power down can also be set on/off, and the data is the default value of chip.

5.1.12 Alarm from indoor fan motor: 2 minutes later after the indoor fan motor is charged, and the impulse from fan motor is not detected, hen send alarm signals.

5.1.13 Force operation:

(1)Force g operation lasts 15 minutes.

(2)The operation stops or after 15 minutes pass by and then close the force operation.

(3)Status conversion stop the strong operation.

(4)Enter such signal controls as "mute", normal operation or timer on, etc., then stop force operation.

(5)Force heating: Revise the temp. setting. Have the function of temp. adjustment.

The air volume is the strong wind speed of heating.

15 later after force operation runs, then prohibit the compressor OFF for 10 minutes (except malfunctions).

(6)Force cooling: Revise the temp. setting. Have the function of temp. adjustment.

The air volume is the strong wind speed of cooling add 50RPM.

After compressor starts running, within 3 minutes the protection of underload is unavailable.

Blowing and defrosting don't have force function.

5.2 Value of Thermistor

5.2.1 Indoor unit

Room sensor

$R_{25^{\circ}\text{C}}=23\text{K} \pm 3.5\%$

$B_{25^{\circ}\text{C}/50^{\circ}\text{C}}=4200\text{K} \pm 3\%$

Temp.(°C)	Max.(KΩ)	Normal(KΩ)	Min.(KΩ)	Tolerance(°C)	
-30	568.8372	501.0746	440.8435	-1.97	1.75
-29	530.9600	468.6491	413.1441	-1.95	1.74
-28	495.8488	438.5314	387.3645	-1.93	1.72
-27	463.2850	410.5433	363.3602	-1.91	1.71
-26	433.0683	384.5212	340.9980	-1.90	1.70
-25	405.0156	360.3153	320.1558	-1.88	1.69
-24	378.9588	337.7879	300.7211	-1.86	1.67
-23	354.7440	316.8126	282.5905	-1.84	1.66
-22	332.2300	297.2732	265.6686	-1.82	1.64
-21	311.2873	279.0627	249.8676	-1.80	1.63
-20	291.7969	262.0831	235.1067	-1.78	1.62
-19	273.6494	246.2437	221.3111	-1.76	1.60

-18	256.7445	231.4612	208.4122	-1.74	1.59
-17	240.9897	217.6590	196.3462	-1.72	1.57
-16	226.3000	204.7662	185.0545	-1.70	1.56
-15	212.5973	192.7176	174.4829	-1.68	1.54
-14	199.8093	181.4531	164.5813	-1.66	1.53
-13	187.8698	170.9169	155.3033	-1.64	1.51
-12	176.7176	161.0578	146.6059	-1.62	1.49
-11	166.2961	151.8284	138.4495	-1.60	1.48
-10	156.5532	143.1847	130.7973	-1.58	1.46
-9	147.4409	135.0863	123.6153	-1.56	1.44
-8	138.9148	127.4956	116.8717	-1.53	1.43
-7	130.9337	120.3778	110.5374	-1.51	1.41
-6	123.4597	113.7009	104.5852	-1.49	1.39
-5	116.4577	107.4349	98.9897	-1.47	1.38
-4	109.8953	101.5523	93.7278	-1.45	1.36
-3	103.7422	96.0274	88.7774	-1.43	1.34
-2	97.9708	90.8365	84.1185	-1.40	1.32
-1	92.5551	85.9574	79.7322	-1.38	1.30
0	87.4712	81.3697	75.6011	-1.36	1.29
1	82.6970	77.0544	71.7088	-1.34	1.27
2	78.2118	72.9937	68.0402	-1.31	1.25
3	73.9966	69.1712	64.5813	-1.29	1.23
4	70.0335	65.5716	61.3188	-1.27	1.21
5	66.3062	62.1807	58.2405	-1.24	1.19
6	62.7992	58.9853	55.3351	-1.22	1.17
7	59.4984	55.9729	52.5917	-1.20	1.15
8	56.3905	53.1320	50.0006	-1.17	1.13
9	53.4631	50.4521	47.5523	-1.15	1.11
10	50.7048	47.9230	45.2384	-1.13	1.09
11	48.1049	45.5355	43.0505	-1.10	1.07
12	45.6534	43.2808	40.9813	-1.08	1.04
13	43.3410	41.1509	39.0236	-1.05	1.02
14	41.1592	39.1381	37.1708	-1.03	1.00
15	39.0998	37.2355	35.4167	-1.00	0.98
16	37.1553	35.4363	33.7555	-0.98	0.96
17	35.3186	33.7344	32.1818	-0.95	0.94
18	33.5833	32.1240	30.6905	-0.93	0.91
19	31.9432	30.5997	29.2769	-0.90	0.89
20	30.3925	29.1565	27.9365	-0.88	0.87
21	28.9259	27.7895	26.6651	-0.85	0.84
22	27.5383	26.4944	25.4589	-0.83	0.82
23	26.2252	25.2670	24.3140	-0.80	0.80
24	24.9822	24.1034	23.2271	-0.78	0.77
25	23.8050	23.0000	22.1950	-0.78	0.77
26	22.7500	21.9499	21.1520	-0.78	0.78

27	21.7477	20.9536	20.1638	-0.82	0.81
28	20.7951	20.0081	19.2272	-0.86	0.85
29	19.8895	19.1104	18.3394	-0.89	0.88
30	19.0285	18.2581	17.4974	-0.93	0.92
31	18.2094	17.4484	16.6988	-0.97	0.95
32	17.4302	16.6792	15.9410	-1.00	0.99
33	16.6885	15.9480	15.2217	-1.04	1.02
34	15.9825	15.2530	14.5389	-1.08	1.06
35	15.3103	14.5920	13.8903	-1.12	1.09
36	14.6700	13.9632	13.2743	-1.16	1.13
37	14.0599	13.3650	12.6889	-1.20	1.16
38	13.4786	12.7957	12.1325	-1.23	1.20
39	12.9244	12.2537	11.6035	-1.27	1.24
40	12.3960	11.7375	11.1004	-1.31	1.27
41	11.8921	11.2459	10.6218	-1.35	1.31
42	11.4113	10.7775	10.1665	-1.39	1.34
43	10.9526	10.3311	9.7330	-1.43	1.38
44	10.5147	9.9056	9.3204	-1.48	1.42
45	10.0967	9.4999	8.9275	-1.52	1.45
46	9.6976	9.1130	8.5532	-1.56	1.49
47	9.3163	8.7439	8.1965	-1.60	1.53
48	8.9521	8.3916	7.8566	-1.64	1.57
49	8.6040	8.0554	7.5327	-1.68	1.60
50	8.2713	7.7345	7.2237	-1.73	1.64
51	7.9531	7.4280	6.9291	-1.77	1.68
52	7.6489	7.1353	6.6480	-1.81	1.72
53	7.3580	6.8556	6.3797	-1.85	1.76
54	7.0796	6.5884	6.1237	-1.90	1.79
55	6.8131	6.3329	5.8793	-1.94	1.83
56	6.5581	6.0887	5.6459	-1.99	1.87
57	6.3140	5.8552	5.4230	-2.03	1.91
58	6.0802	5.6318	5.2100	-2.07	1.95
59	5.8563	5.4181	5.0065	-2.12	1.99
60	5.6417	5.2136	4.8120	-2.16	2.03
61	5.4361	5.0178	4.6260	-2.21	2.07
62	5.2391	4.8304	4.4481	-2.25	2.11
63	5.0502	4.6510	4.2780	-2.30	2.15
64	4.8691	4.4791	4.1153	-2.35	2.19
65	4.6954	4.3145	3.9596	-2.39	2.23
66	4.5287	4.1567	3.8105	-2.44	2.27
67	4.3689	4.0055	3.6678	-2.49	2.31
68	4.2154	3.8605	3.5312	-2.53	2.35
69	4.0682	3.7216	3.4004	-2.58	2.39
70	3.9268	3.5883	3.2750	-2.63	2.43
71	3.7910	3.4605	3.1549	-2.68	2.48

72	3.6606	3.3378	3.0398	-2.73	2.52
73	3.5353	3.2201	2.9294	-2.77	2.56
74	3.4150	3.1072	2.8237	-2.82	2.60
75	3.2993	2.9987	2.7222	-2.87	2.64
76	3.1881	2.8946	2.6249	-2.92	2.68
77	3.0812	2.7946	2.5316	-2.97	2.73
78	2.9785	2.6986	2.4420	-3.02	2.77
79	2.8796	2.6063	2.3560	-3.07	2.81
80	2.7845	2.5176	2.2735	-3.12	2.86
81	2.6931	2.4324	2.1943	-3.17	2.90
82	2.6050	2.3505	2.1182	-3.22	2.94
83	2.5203	2.2717	2.0451	-3.28	2.99
84	2.4388	2.1960	1.9749	-3.33	3.03
85	2.3602	2.1231	1.9075	-3.38	3.07
86	2.2846	2.0530	1.8426	-3.43	3.12
87	2.2118	1.9856	1.7803	-3.48	3.16
88	2.1416	1.9207	1.7204	-3.54	3.20
89	2.0740	1.8582	1.6628	-3.59	3.25
90	2.0089	1.7981	1.6074	-3.64	3.29
91	1.9461	1.7402	1.5541	-3.70	3.34
92	1.8856	1.6844	1.5028	-3.75	3.38
93	1.8272	1.6307	1.4535	-3.80	3.43
94	1.7709	1.5789	1.4060	-3.86	3.47
95	1.7166	1.5291	1.3603	-3.91	3.52
96	1.6643	1.4810	1.3163	-3.97	3.56
97	1.6138	1.4347	1.2739	-4.02	3.61
98	1.5650	1.3900	1.2331	-4.08	3.66
99	1.5180	1.3470	1.1937	-4.13	3.70
100	1.4726	1.3054	1.1559	-4.19	3.75
101	1.4287	1.2654	1.1194	-4.24	3.80
102	1.3864	1.2268	1.0842	-4.30	3.84
103	1.3455	1.1895	1.0503	-4.36	3.89
104	1.3060	1.1535	1.0176	-4.42	3.94
105	1.2679	1.1188	0.9860	-4.47	3.98
106	1.2310	1.0853	0.9556	-4.53	4.03
107	1.1954	1.0529	0.9263	-4.59	4.08
108	1.1610	1.0217	0.8980	-4.65	4.13
109	1.1277	0.9915	0.8707	-4.70	4.17
110	1.0955	0.9624	0.8443	-4.76	4.22
111	1.0644	0.9342	0.8189	-4.82	4.27
112	1.0344	0.9070	0.7943	-4.88	4.32
113	1.0053	0.8807	0.7706	-4.94	4.37
114	0.9771	0.8553	0.7478	-5.00	4.41
115	0.9499	0.8307	0.7256	-5.06	4.46
116	0.9235	0.8070	0.7043	-5.12	4.51

117	0.8980	0.7840	0.6837	-5.18	4.56
118	0.8734	0.7618	0.6637	-5.24	4.61
119	0.8495	0.7404	0.6445	-5.30	4.66
120	0.8263	0.7196	0.6258	-5.36	4.71

Pipe Sensor

R25°C=10K ±3%

B25°C/50°C=3700K±3%

Temp.((°C))	Max.(KΩ)	Normal(KΩ)	Min.(KΩ)	Tolerance(°C)	
-30	165.2170	147.9497	132.3678	-1.94	1.75
-29	155.5754	139.5600	125.0806	-1.93	1.74
-28	146.5609	131.7022	118.2434	-1.91	1.73
-27	138.1285	124.3392	111.8256	-1.89	1.71
-26	130.2371	117.4366	105.7989	-1.87	1.70
-25	122.8484	110.9627	100.1367	-1.85	1.69
-24	115.9272	104.8882	94.8149	-1.83	1.67
-23	109.4410	99.1858	89.8106	-1.81	1.66
-22	103.3598	93.8305	85.1031	-1.80	1.64
-21	97.6556	88.7989	80.6728	-1.78	1.63
-20	92.3028	84.0695	76.5017	-1.76	1.62
-19	87.2775	79.6222	72.5729	-1.74	1.60
-18	82.5577	75.4384	68.8710	-1.72	1.59
-17	78.1230	71.5010	65.3815	-1.70	1.57
-16	73.9543	67.7939	62.0907	-1.68	1.55
-15	70.0342	64.3023	58.9863	-1.66	1.54
-14	66.3463	61.0123	56.0565	-1.64	1.52
-13	62.8755	57.9110	53.2905	-1.62	1.51
-12	59.6076	54.9866	50.6781	-1.60	1.49
-11	56.5296	52.2278	48.2099	-1.58	1.47
-10	53.6294	49.6244	45.8771	-1.56	1.46
-9	50.8956	47.1666	43.6714	-1.54	1.44
-8	48.3178	44.8454	41.5851	-1.51	1.42
-7	45.8860	42.6525	39.6112	-1.49	1.40
-6	43.5912	40.5800	37.7429	-1.47	1.39
-5	41.4249	38.6207	35.9739	-1.45	1.37
-4	39.3792	36.7676	34.2983	-1.43	1.35
-3	37.4465	35.0144	32.7108	-1.41	1.33
-2	35.6202	33.3552	31.2062	-1.38	1.31
-1	33.8936	31.7844	29.7796	-1.36	1.29
0	32.2608	30.2968	28.4267	-1.34	1.28
1	30.7162	28.8875	27.1431	-1.32	1.26
2	29.2545	27.5519	25.9250	-1.29	1.24
3	27.8708	26.2858	24.7686	-1.27	1.22
4	26.5605	25.0851	23.6704	-1.25	1.20
5	25.3193	23.9462	22.6273	-1.23	1.18

6	24.1432	22.8656	21.6361	-1.20	1.16
7	23.0284	21.8398	20.6939	-1.18	1.14
8	21.9714	20.8659	19.7982	-1.15	1.12
9	20.9688	19.9409	18.9463	-1.13	1.09
10	20.0176	19.0621	18.1358	-1.11	1.07
11	19.1149	18.2270	17.3646	-1.08	1.05
12	18.2580	17.4331	16.6305	-1.06	1.03
13	17.4442	16.6782	15.9315	-1.03	1.01
14	16.6711	15.9601	15.2657	-1.01	0.99
15	15.9366	15.2770	14.6315	-0.98	0.96
16	15.2385	14.6268	14.0271	-0.96	0.94
17	14.5748	14.0079	13.4510	-0.93	0.92
18	13.9436	13.4185	12.9017	-0.91	0.90
19	13.3431	12.8572	12.3778	-0.88	0.87
20	12.7718	12.3223	11.8780	-0.86	0.85
21	12.2280	11.8126	11.4011	-0.83	0.83
22	11.7102	11.3267	10.9459	-0.81	0.80
23	11.2172	10.8634	10.5114	-0.78	0.78
24	10.7475	10.4216	10.0964	-0.75	0.75
25	10.3000	10.0000	9.7000	-0.75	0.75
26	9.8975	9.5974	9.2980	-0.76	0.76
27	9.5129	9.2132	8.9148	-0.80	0.80
28	9.1454	8.8465	8.5496	-0.84	0.83
29	8.7942	8.4964	8.2013	-0.87	0.86
30	8.4583	8.1621	7.8691	-0.91	0.90
31	8.1371	7.8428	7.5522	-0.95	0.93
32	7.8299	7.5377	7.2498	-0.98	0.97
33	7.5359	7.2461	6.9611	-1.02	1.00
34	7.2546	6.9673	6.6854	-1.06	1.04
35	6.9852	6.7008	6.4222	-1.10	1.07
36	6.7273	6.4459	6.1707	-1.13	1.11
37	6.4803	6.2021	5.9304	-1.17	1.14
38	6.2437	5.9687	5.7007	-1.21	1.18
39	6.0170	5.7454	5.4812	-1.25	1.22
40	5.7997	5.5316	5.2712	-1.29	1.25
41	5.5914	5.3269	5.0704	-1.33	1.29
42	5.3916	5.1308	4.8783	-1.37	1.33
43	5.2001	4.9430	4.6944	-1.41	1.36
44	5.0163	4.7630	4.5185	-1.45	1.40
45	4.8400	4.5905	4.3500	-1.49	1.44
46	4.6708	4.4252	4.1887	-1.53	1.47
47	4.5083	4.2666	4.0342	-1.57	1.51
48	4.3524	4.1145	3.8862	-1.61	1.55
49	4.2026	3.9686	3.7443	-1.65	1.59
50	4.0588	3.8287	3.6084	-1.70	1.62

51	3.9206	3.6943	3.4780	-1.74	1.66
52	3.7878	3.5654	3.3531	-1.78	1.70
53	3.6601	3.4416	3.2332	-1.82	1.74
54	3.5374	3.3227	3.1183	-1.87	1.78
55	3.4195	3.2085	3.0079	-1.91	1.82
56	3.3060	3.0989	2.9021	-1.95	1.85
57	3.1969	2.9935	2.8005	-2.00	1.89
58	3.0919	2.8922	2.7029	-2.04	1.93
59	2.9909	2.7948	2.6092	-2.08	1.97
60	2.8936	2.7012	2.5193	-2.13	2.01
61	2.8000	2.6112	2.4328	-2.17	2.05
62	2.7099	2.5246	2.3498	-2.22	2.09
63	2.6232	2.4413	2.2700	-2.26	2.13
64	2.5396	2.3611	2.1932	-2.31	2.17
65	2.4591	2.2840	2.1195	-2.36	2.21
66	2.3815	2.2098	2.0486	-2.40	2.25
67	2.3068	2.1383	1.9803	-2.45	2.29
68	2.2347	2.0695	1.9147	-2.49	2.34
69	2.1652	2.0032	1.8516	-2.54	2.38
70	2.0983	1.9393	1.7908	-2.59	2.42
71	2.0337	1.8778	1.7324	-2.63	2.46
72	1.9714	1.8186	1.6761	-2.68	2.50
73	1.9113	1.7614	1.6219	-2.73	2.54
74	1.8533	1.7064	1.5697	-2.78	2.58
75	1.7974	1.6533	1.5194	-2.83	2.63
76	1.7434	1.6021	1.4710	-2.88	2.67
77	1.6913	1.5528	1.4243	-2.92	2.71
78	1.6409	1.5051	1.3794	-2.97	2.75
79	1.5923	1.4592	1.3360	-3.02	2.80
80	1.5454	1.4149	1.2942	-3.07	2.84
81	1.5000	1.3721	1.2540	-3.12	2.88
82	1.4562	1.3308	1.2151	-3.17	2.93
83	1.4139	1.2910	1.1776	-3.22	2.97
84	1.3730	1.2525	1.1415	-3.27	3.01
85	1.3335	1.2153	1.1066	-3.32	3.06
86	1.2953	1.1794	1.0730	-3.38	3.10
87	1.2583	1.1448	1.0405	-3.43	3.15
88	1.2226	1.1113	1.0092	-3.48	3.19
89	1.1880	1.0789	0.9789	-3.53	3.24
90	1.1546	1.0476	0.9497	-3.58	3.28
91	1.1223	1.0174	0.9215	-3.64	3.33
92	1.0910	0.9882	0.8942	-3.69	3.37
93	1.0607	0.9599	0.8679	-3.74	3.42
94	1.0314	0.9326	0.8424	-3.80	3.46
95	1.0030	0.9061	0.8179	-3.85	3.51

96	0.9756	0.8806	0.7941	-3.90	3.55
97	0.9490	0.8558	0.7711	-3.96	3.60
98	0.9232	0.8319	0.7489	-4.01	3.64
99	0.8983	0.8088	0.7275	-4.07	3.69
100	0.8741	0.7863	0.7067	-4.12	3.74
101	0.8507	0.7646	0.6867	-4.18	3.78
102	0.8281	0.7436	0.6672	-4.23	3.83
103	0.8061	0.7233	0.6484	-4.29	3.88
104	0.7848	0.7036	0.6303	-4.34	3.92
105	0.7641	0.6845	0.6127	-4.40	3.97
106	0.7441	0.6661	0.5957	-4.46	4.02
107	0.7247	0.6482	0.5792	-4.51	4.07
108	0.7059	0.6308	0.5632	-4.57	4.12
109	0.6877	0.6140	0.5478	-4.63	4.16
110	0.6700	0.5977	0.5328	-4.69	4.21
111	0.6528	0.5820	0.5183	-4.74	4.26
112	0.6361	0.5667	0.5043	-4.80	4.31
113	0.6200	0.5518	0.4907	-4.86	4.36
114	0.6043	0.5374	0.4775	-4.92	4.41
115	0.5891	0.5235	0.4648	-4.98	4.45
116	0.5743	0.5100	0.4524	-5.04	4.50
117	0.5600	0.4968	0.4404	-5.10	4.55
118	0.5460	0.4841	0.4288	-5.16	4.60
119	0.5325	0.4717	0.4175	-5.22	4.65
120	0.5194	0.4597	0.4066	-5.28	4.70

6. System Configuration

6.1 System Configuration

After the installation and test operation of the room air conditioner have been completed, it should be operated and handled as described below. Every user would like to know the correct method of operation of the room air conditioner, to check if it is capable of cooling (or heating) well, and to know a clever method of using it. In order to meet this expectation of the users, giving sufficient explanations taking enough time can be said to reduce about 80% of the requests for servicing. However good the installation work is and however good the functions are, the customer may blame either the room air conditioner or its installation work because of improper handling. The installation work and handing over of the unit can only be considered to have been completed when its handling has been explained to the user without using technical terms but giving full knowledge of the equipment.

6.2 Instruction

Cautions

Disposal of the old air conditioner

Before disposing an old air conditioner that goes out of use, please make sure it's inoperative and safe. Unplug the air conditioner in order to avoid the risk of child entrapment.

It must be noticed that air conditioner system contains refrigerants, which require specialized waste disposal. The valuable materials contained in an air conditioner can be recycled. Contact your local waste disposal center for proper disposal of an old air conditioner and contact your local authority or your dealer if you have any question. Please ensure that the pipework of your air conditioner does not get damaged prior to being picked up by the relevant waste disposal center, and contribute to environmental awareness by insisting on an appropriate, anti-pollution method of disposal.

Disposal of the packaging of your new air conditioner

All the packaging materials employed in the package of your new air conditioner may be disposed without any danger to the environment.

The cardboard box may be broken or cut into smaller pieces and given to a waste paper disposal service. The wrapping bag made of polyethylene and the polyethylene foam pads contain no fluorochloric hydrocarbon.

All these valuable materials may be taken to a waste collecting center and used again after adequate recycling.

Consult your local authorities for the name and address of the waste materials collecting centers and waste paper disposal services nearest to your house.

Safety Instructions and Warnings

Before starting the air conditioner, read the information given in the User's Guide carefully. The User's Guide contains very important observations relating to the assembly, operation and maintenance of the air conditioner.

The manufacturer does not accept responsibility for any damages that may arise due to non-observation of the following instruction.

- Damaged air conditioners are not to be put into operation. In case of doubt, consult your supplier.
- Use of the air conditioner is to be carried out in strict compliance with the relative instructions set forth in the User's Guide.
- Installation shall be done by professional people, don't install unit by yourself.
- For the purpose of the safety, the air conditioner must be properly grounded in accordance with specifications.
- Always remember to unplug the air conditioner before opening inlet grill. Never unplug your air conditioner by pulling on the power cord. Always grip plug firmly and pull straight out from the outlet.
- All electrical repairs must be carried out by qualified electricians. Inadequate repairs may result in a major source of danger for the user of the air conditioner.
- Do not damage any parts of the air conditioner that carry refrigerant by piercing or perforating the air conditioner's tubes with sharp or pointed items, crushing or twisting any tubes, or scraping the coatings off the surfaces. If the refrigerant spurts out and gets into eyes, it may result in serious eye injuries.

Cautions

- Do not obstruct or cover the ventilation grille of the air conditioner. Do not put fingers or any other things into the inlet/outlet and swing louver.
 - Do not allow children to play with the air conditioner. In no case should children be allowed to sit on the outdoor unit.
7. The appliance is not intended for use by young children or infirm persons without supervision.
 8. Young children should be supervised to ensure that they do not play with the appliance.
 9. Please employ the proper power plug, which fit into the power supply cord.
 10. The power plug and connecting cable must have acquired the local attestation.
 11. In order to protect the units, please turn off the A/C first, and at least 30 seconds later, cutting off the power.

Specifications

- The refrigerating circuit is leak-proof.

The machine is adaptive in following situation

1. Applicable ambient temperature range:

Cooling	Indoor	Maximum:D.B/W.B Minimum:D.B/W.B	32°C/23°C 18°C/14°C
	Outdoor	Maximum:D.B/W.B Minimum:D.B	43°C/26°C 18°C
Heating	Indoor	Maximum:D.B Minimum: D.B	27°C 15°C
	Outdoor	Maximum:D.B/W.B Minimum:D.B	27°C/18°C -15°C

2. If the power supply cord is damaged, it must be replaced by the manufacturer or its service agent or a similar qualified person.
3. If the fuse of indoor unit on PC board is broken, please change it with the type of T. 3.15A/ 250V.
4. The wiring method should be in line with the local wiring standard.
5. After installation, the power plug should be easily reached.
6. The waste battery should be disposed properly.

Cautions

Safety Instruction

- Please read the following Safety Instructions carefully prior to use.
- The instructions are classified into two levels, WARNING and CAUTION according to the seriousness of possible risks and damages as follows. Compliance to the instructions are strictly required for safety use.

Installation

⚠ WARNING

Please call Sales/Service Shop for the Installation.
Do not attempt to install the air conditioner by yourself because improper works may cause electric shock, fire, water leakage.

Installation in an inadequate place may cause accidents. Do not install in the following place.

⚠ CAUTION

Connect the earth cable.

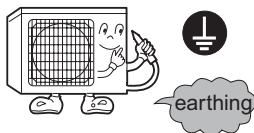

Do not install in the place where there is any possibility of inflammable gas leakage around the unit.



PROHIBITION

Do not get the unit exposed to vapor or oil steam.



PROHIBITION





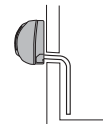

Check proper installation of the drainage securely



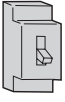

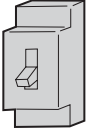
STRICT ENFORCEMENT

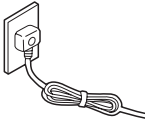
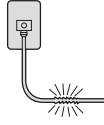
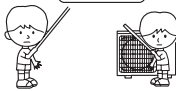

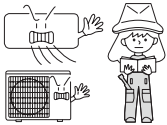
Cautions

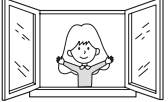
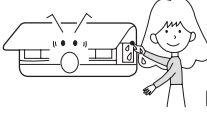
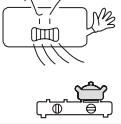
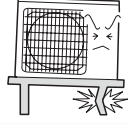
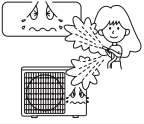
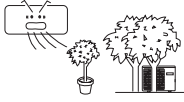
⚠ WARNING		
<p>When abnormality such as burnt-smell found, immediately stop the operation button and contact sales shop.</p>  OFF 		<p>Use an exclusive power source with a circuit breaker</p> 
<p>! STRICT ENFORCEMENT</p>		<p>! STRICT ENFORCEMENT</p>
<p>Connect power supply cord to the outlet completely</p>  <p style="text-align: center;">! STRICT ENFORCEMENT</p>	<p>Use the proper voltage</p>  <p style="text-align: center;">! STRICT ENFORCEMENT</p>	<p>Do not use power supply cord extended or connected in halfway</p> <p style="text-align: center;">⊘ PROHIBITION</p>
<p>Do not use power supply cord in a bundle.</p>  <p style="text-align: center;">⊘ PROHIBITION</p>	<p>Take care not to damage the power supply cord.</p>  <p style="text-align: center;">⊘ PROHIBITION</p>	<p>Do not insert objects into the air inlet or outlet.</p>  <p style="text-align: center;">⊘ PROHIBITION</p>
<p>Do not start or stop the operation by disconnecting the power supply cord and so on.</p>  <p style="text-align: center;">⊘ PROHIBITION</p>	<p>Do not channel the air flow directly at people, especially at infants or the aged.</p>  <p style="text-align: center;">⊘ PROHIBITION</p>	<p>Do not try to repair or reconstruct by yourself.</p>  <p style="text-align: center;">⊘ PROHIBITION</p>

⚠ CAUTION		
<p>Do not use for the purpose of storage of food, art work, precise equipment, breeding, or cultivation.</p>  <p style="text-align: center;">⊘ PROHIBITION</p>	<p>Take fresh air occasionally especially when gas appliance is running at the same time.</p>  <p style="text-align: center;">! STRICT ENFORCEMENT</p>	<p>Do not operate the switch with wet hand.</p>  <p style="text-align: center;">⊘ PROHIBITION</p>
<p>Do not install the unit near a fireplace or other heating apparatus.</p>  <p style="text-align: center;">⊘ PROHIBITION</p>	<p>Check good condition of the installation stand</p>  <p style="text-align: center;">⊘ PROHIBITION</p>	<p>Do not pour water onto the unit for cleaning</p>  <p style="text-align: center;">⊘ PROHIBITION</p>
<p>Do not place animals or plants in the direct path of the air flow</p>  <p style="text-align: center;">⊘ PROHIBITION</p>	<p>Do not place any objects on or climb on the unit.</p>  <p style="text-align: center;">⊘ PROHIBITION</p>	<p>Do not place flower vase or water containers on the top of the unit.</p>  <p style="text-align: center;">⊘ PROHIBITION</p>

Parts and Functions

Indoor Unit

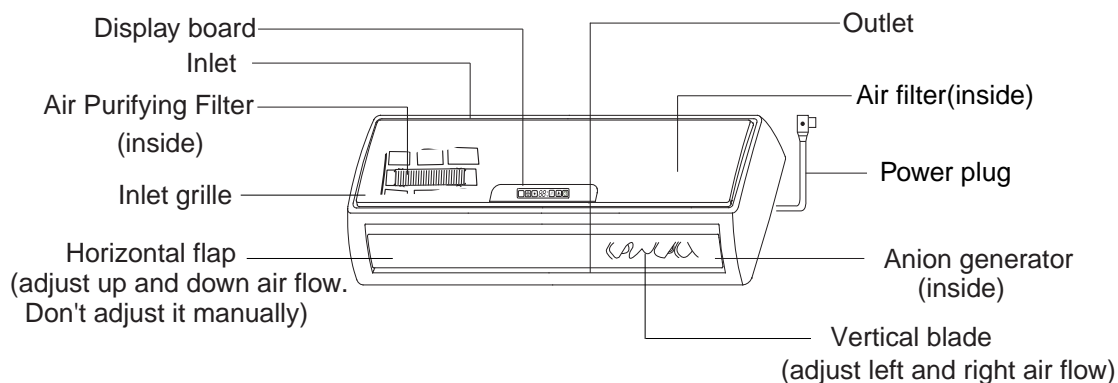

Actual inlet grille may vary from the one shown in the manual according to the product purchased

For 22k unit, the power plug is on the outdoor unit

Outdoor Unit

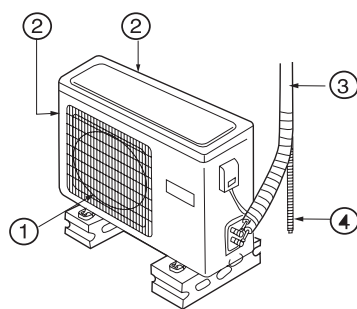

HSU-22LEA03

HSU-22HEA03

① OUTLET

② INLET

③ CONNECTING PIPING AND ELECTRICAL WIRING

④ DRAIN HOSE

Parts and Functions

Remote controller

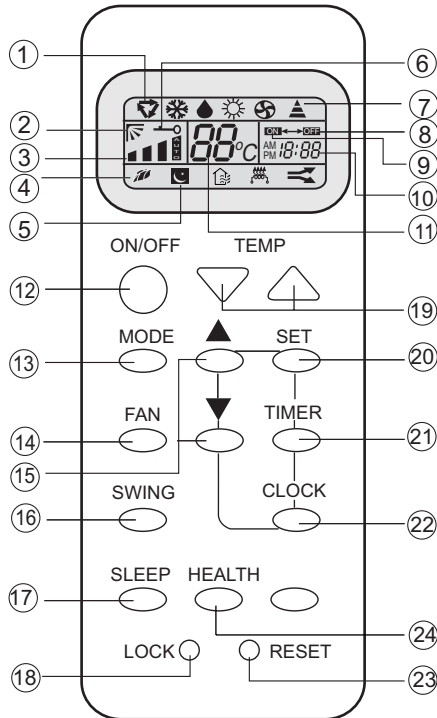

1. Operation mode display

Operation mode	AUTO	COOL	DRY	HEAT	FAN
Remote controller					
Display board					

2. SWING display
3. FAN SPEED display
4. HEALTH display
5. SLEEP display
6. LOCK display

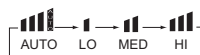

Display board

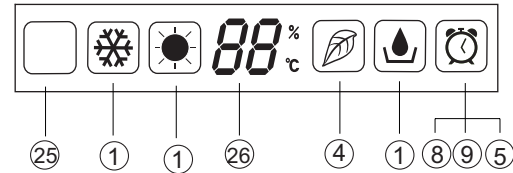

7. SIGNAL SENDING display
8. TIMER OFF display
9. TIMER ON display
10. CLOCK display
11. TEMP display
12. POWER ON/OFF
Used for unit start and stop.
13. MODE
Used to select AUTO run, COOL, DRY and FAN operation
14. FAN
Used to select fan speed LO, MED, HI, AUTO
15. HOUR
Used to set clock and timer setting.
16. SWING
Used to set auto fan direction.
17. SLEEP
Used to select sleep mode.
18. LOCK
Used to lock buttons and LCD display.
19. TEMP.
Used to select your desired temp.
20. SET
Used to confirm timer and clock settings.
21. TIMER
Used to select TIMER ON, TIMER OFF, TIMER ON-OFF
22. CLOCK
Used to set correct time
23. RESET
Used to reset the controller back to normal condition.
24. HEALTH
Used to operate the healthy function
25. Singal receiver hole
26. Ambient temp.display

When receiving the remote control signal, display the set temperature and in the rest time the room temperature is displayed and this room temperature is only for reference.

Clock set

When unit is started for the first time and after replacing batteries in remote controller, clock should be adjusted as follows:

Press CLOCK button, "AM" or "PM" flashes.

Press Δ or ∇ to set correct time. Each press will increase or decrease 1min. If the button is kept depressed, time will change quickly.

After time setting is confirmed, press SET, "AM" and "PM" stop flashing, while clock starts working.

NOTE: Cooling only unit do not have displays and functions related with heating

Hints

After replacing with new batteries, remote controller will conduct self-check, displaying all information on LCD. Then, it will become normal.

Parts and Functions

If the unit which you purchased has not healthy function, Remote controller should like the following figure:

Remote controller

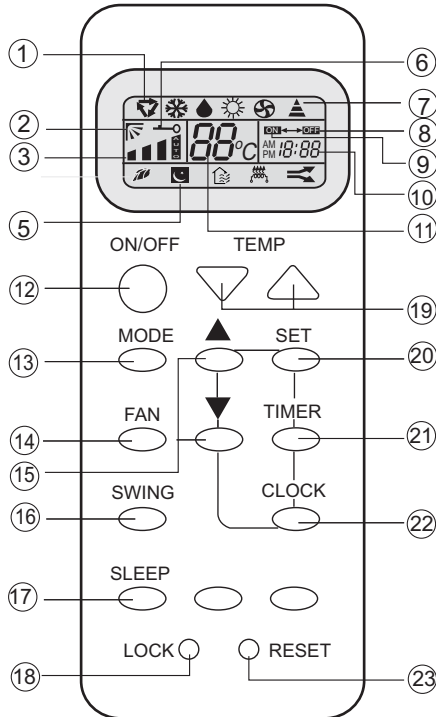

1. Operation mode display

Operation mode	AUTO	COOL	DRY	HEAT	FAN
Remote controller					
Display board					

2. SWING display

3. FAN SPEED display

5. SLEEP display

6. LOCK display



Display board

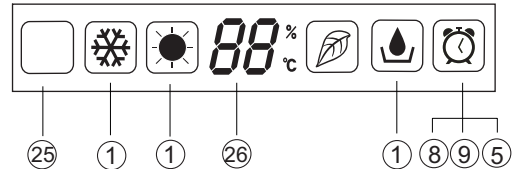

7. SIGNAL SENDING display

8. TIMER OFF display

9. TIMER ON display

10. CLOCK display

11. TEMP display

12. POWER ON/OFF

Used for unit start and stop.

13. MODE

Used to select AUTO run, COOL, DRY and FAN operation

14. FAN

Used to select fan speed LO, MED, HI, AUTO

15. HOUR

Used to set clock and timer setting.

16. SWING

Used to set auto fan direction.

17. SLEEP

Used to select sleep mode.

18. LOCK

Used to lock buttons and LCD display.

19. TEMP.

Used to select your desired temp.

20. SET

Used to confirm timer and clock settings.

21. TIMER

Used to select TIMER ON, TIMER OFF, TIMER ON-OFF

22. CLOCK

Used to set correct time

23. RESET

Used to reset the controller back to normal condition.

24. Singal receiver hole

25. Ambient temp. display

When receiving the remote control signal, display the set temperature and in the rest time the room temperature is displayed and this room temperature is only for reference.

Clock set

When unit is started for the first time and after replacing batteries in remote controller, clock should be adjusted as follows:

Press CLOCK button, "AM" or "PM" flashes.

Press Δ or ∇ to set correct time. Each press will increase or decrease 1min. If the button is kept depressed, time will change quickly.

After time setting is confirmed, press SET, "AM" and "PM" stop flashing, while clock starts working.

NOTE: Cooling only unit do not have displays and functions related with heating

Hints: After replacing with new batteries, remote controller will conduct self-check, displaying all information on LCD. Then, it will become normal.

Operation

Remote controller's operation

- When in use, put the signal transmission head directly to the receiver hole on the indoor unit.
- The distance between the signal transmission head and the receiver hole should be within 7m without any obstacle as well.
- Don't throw the controller, prevent it from being damaged.
- When electronic-started type fluorescent lamp or change-over type fluorescent lamp or wireless telephone is installed in the room, the receiver is apt to be disturbed in receiving the signals so the distance to the indoor unit should be shorter.

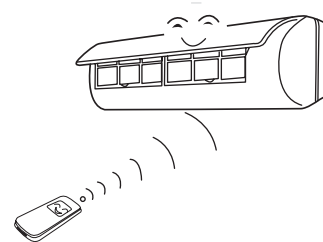

Loading of the battery

Load the batteries as illustrated. 2 R-03 batteries, resetting key (cylinder)

Remove the battery cover:

Slightly press "▼" and push down the cover.

Load the battery:

Be sure that the loading is in line with the "+" and "-" pole request as illustrated.

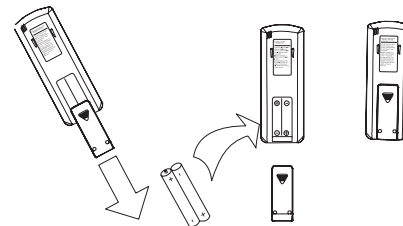

Put on the cover again

Confirmation indicator:

In disorderation, reload the batteries or load the new batteries after 6mins.

Note:

Use two new same-typed batteries when loading.

If the remote controller can't run normally or doesn't work at all, use a sharp pointed item to press the reset key.

Hint:

Remove the batteries in case unit won't be in usage for a long period.

If there are any display after taking-out just need to press reset key.

Power failure resume(please set and apply as necessary)

If sudden power failure occurs, the unit will resume original operation when power is supplied again.

Note: When sudden power failure happens during unit operation in power failure resume mode, if the air conditioner is not desired for use in a long period, please shut off the power supply in case that the unit automatically resume operation when power is re-supplied, or press ON/OFF to turn off the unit when power resumes.

Operation

Auto Operation



24°C

(1) Unit start

Press ON/OFF on the remote controller, unit starts.

(2) Select operation mode

Press MODE button. For each press, operation mode changes as follows:

Remote controller:



Then Select Auto operation

(3) Fan speed selection

Press FAN button. For each press, fan speed changes as follows:

Remote controller:



Air conditioner is running under displayed fan speed.
When FAN is set to AUTO, the air conditioner automatically adjusts the fan speed according to room temperature.

(4) Unit stop

Press ON/OFF button, the unit stops.

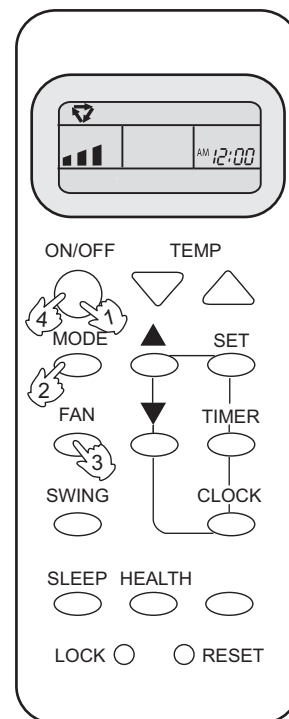

Hints

Remote controller can memorize settings in each operation mode. To run it next time just select the operation mode and it will start with the previous setting.

No reelecting is needed. (TIMER ON/OFF, SLEEP, SWING needs reelecting)

Cautions:

On cooling only unit, heating mode is not available,
After replacing batteries, press ON/OFF, and display becomes as follows:

Operation mode: AUTO, Temp. :No

Note:

The above information is the explanation of the displayed information therefore varies with those displayed in actual operation.

Operation

Cool Operation



24°C

(1) Unit start

Press ON/OFF button, unit starts.

Previous operation status appears on display. (Not Timer setting)

(2) Select operation mode

Press MODE button. For each press, operation mode changes as follows:



Unit will run in operation mode displayed on LCD.

Stop display at your desired mode.

(3) Select temp. setting

Press TEMP button.

△ Every time the button is pressed, temp. setting increases 1°C

▽ Every time the button is pressed, temp. setting decreases 1°C

Unit will start running to reach the temp. setting on LCD.

(4) Fan speed selection

Press FAN button. For each press, fan speed changes as follows:

Remote controller:

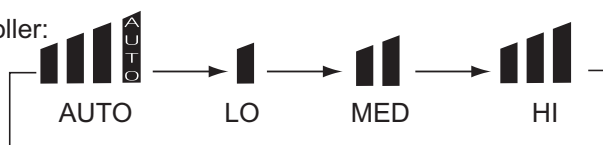

Air conditioner is running under displayed fan speed.

When FAN is set to AUTO, the air conditioner automatically adjusts the fan speed according to room temperature.

(5) Unit stop

Press ON/OFF button, the unit stops.

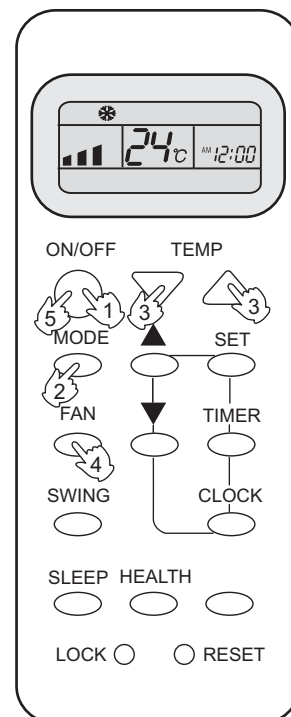

Hints

On cooling only unit, heating mode is not available.

Remote controller can memorize each operation status. When starting it next time, just press ON/OFF button and unit will run in previous status.

No reelecting is needed. (TIMER ON/OFF, SLEEP, SWING needs reelecting)

Operation

Dry Operation

24°C



(1) Unit start

Press ON/OFF button, unit starts.

Previous operation status appears on display. (Not Timer setting)

(2) Select operation mode

Press MODE button. For each press, operation mode changes as follows:



Unit will run in operation mode displayed on LCD.

Stop display at your desired mode.

(3) Select temp. setting

Press TEMP button.

△ Every time the button is pressed, temp. setting increases 1°C

▽ Every time the button is pressed, temp. setting decreases 1°C

Unit will start running to reach the temp. setting on LCD.

(4) Fan speed selection

Press FAN button. For each press, fan speed changes as follows:

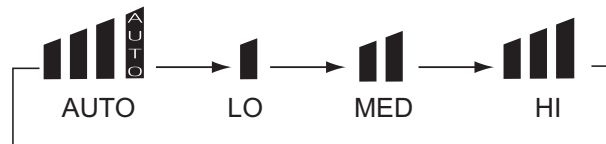

Unit runs at the speed displayed on LCD.

In DRY mode, when room temperature becomes lower than temp.setting+2°C, unit will run intermittently at LOW speed regardless of FAN setting.

(5) Unit stop

Press ON/OFF button, the unit stops.

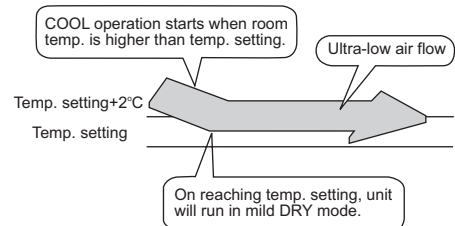
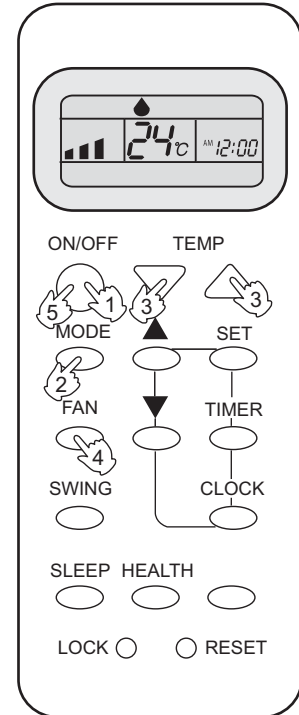

Hints

On cooling only unit, heating mode is not available.

Remote controller can memorize each operation status. When starting it next time, just press ON/OFF button and unit will run in previous status.

No reelecting is needed. (TIMER ON/OFF, SLEEP, SWING needs reelecting)

Operation

Heat Operation



(1) Unit start

Press ON/OFF button, unit starts.

Previous operation status appears on display. (Not Timer setting)

(2) Select operation mode

Press MODE button. For each press, operation mode changes as follows:



Unit will run in operation mode displayed on LCD.

Stop display at your desired mode.

(3) Select temp. setting

Press TEMP button.

△ Every time the button is pressed, temp. setting increases 1°C

▽ Every time the button is pressed, temp. setting decreases 1°C

Unit will start running to reach the temp. setting on LCD.

(4) Fan speed selection

Press FAN button. For each press, fan speed changes as follows:

Remote controller:

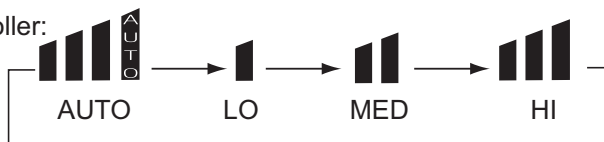

IN HEAT mode, warm air will blow out after a short period of the time due to cold-draft prevention function. When FAN is set to AUTO, the air conditioner automatically adjusts the fan speed according to room temperature.

(5) Unit stop

Press ON/OFF button, the unit stops.

Note: On cooling only unit, heating mode is not available.

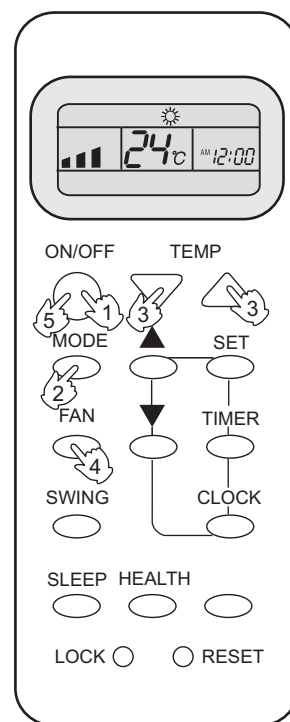

Hints

Remote controller can memorize each operation status. When starting it next time, just press ON/OFF button and unit will run in previous status.

Operation

Fan Operation

24°C

(1) Unit start

Press ON/OFF button, unit starts.

Previous operation status appears on display. (Not Timer setting)

(2) Select operation mode

Press MODE button. For each press, operation mode changes as follows:



Unit will run in operation mode displayed on LCD.

Stop display at your desired mode.

(3) Fan speed selection

Press FAN button. For each press, fan speed changes as follows:



Unit runs at the speed displayed on LCD.

(4) Unit stop

Press ON/OFF button, the unit stops.

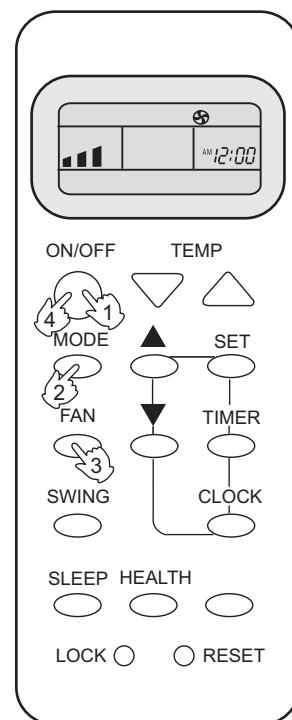

Note: On cooling only unit ,heating mode is not available.

Hints

In FAN operation mode, the unit will not operate in COOL or HEAT mode but only in FAN mode. AUTO is not available in FAN mode, And temp .setting is disabled.

In FAN mode,SLEEP operation is not available.

Operation

Air Flow Direction Adjustment

1. Status display of air sending

Horizontal flap

Pos.1 (Cool/Dry standard position)

Pos.2 (Upward swing)

Pos.3 (Downward swing)

Pos.4 (Auto swing)

Remote controller

Blank

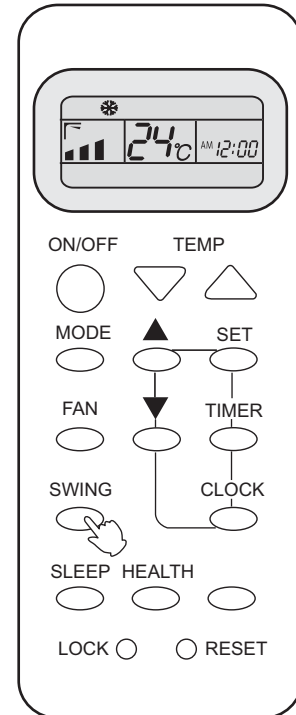

2. Up and down air flow direction(Use remote controller)

For each press of SWING button, air flow direction on remote controller display as follows according to different operation modes:

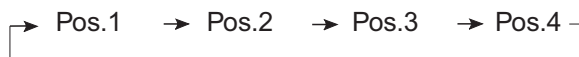

The horizontal flap will swing according to the above positions

3. Left and right air flow adjustment(manual)

Move the vertical blade by a knob on air conditioner to adjust left and right direction referring to Fig.

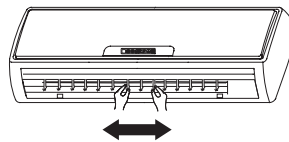

Cautions:

- Do not try to adjust the flap by hand.
- When adjusting the flap by hand, turn off the unit, and use the remote controller to restart the unit.
- When humidity is high, condensate water might occur at air outlet if all vertical louvers are adjusted to left or right.
- It is advisable not to keep horizontal flap at downward position for a long time in COOL or DRY mode, otherwise, condensate water might occur.

Hints

- As cold air flows downward in COOL mode, adjusting air flow horizontally will be much more helpful for a better air circulation.

Operation

Comfortable SLEEP



24°C



Operation

Before going to bed, you can simply press the SLEEP button and unit will operate in SLEEP mode and bring you a sound sleep.

Use of SLEEP function

After the unit starts, set the operation status, then press SLEEP button before which the clock must be adjusted and time being set.

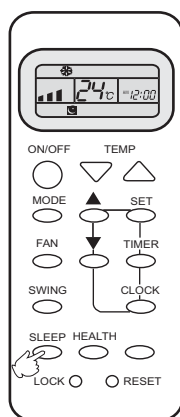

Operation Mode

1. In COOL, DRY mode

1 hours after SLEEP mode starts, temp. will become 1°C higher than temp. setting. After another 1 hours, temp. rises by 1°C further. The unit will run for further 6 hours then stops. Temp. is higher than temp. setting so that room temperature won't be too low for your sleep.

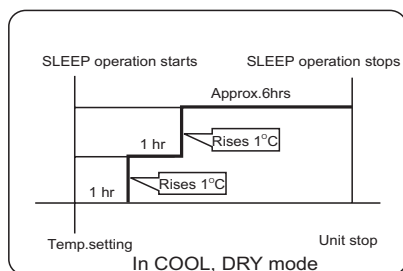

2. In HEAT mode

1 hours after SLEEP mode starts, temp will become 2°C lower than temp.setting. After another 1 hours, temp decrease by 2°C further. After more another 3 hours, temp. rises by 1°C further. The unit will run for

further 3 hours then stops. Temp. is lower than temp. setting so that room temperature won't be too high for your sleep.

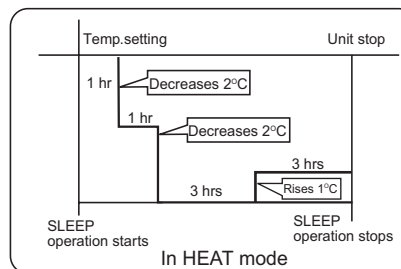

3. In AUTO mode

The unit operates in corresponding sleep mode adapted to the automatically selected operation mode.

4. In FAN mode

It has no SLEEP function.

5. When TIMER function is set, the sleeping function can't be set up. After the sleeping function is set up, if user resets TIMER function, the sleeping function will be cancelled; the machine will be in the state of timing-on.

6. Note to the power failure resume:

press the sleep button ten times in five seconds and enter this function after hearing four sounds. And press the sleep button ten times within five seconds and leave this function after hearing two sounds.

Power Failure Resume Function

If the unit is started for the first time, the compressor will not start running unless 3 minutes have elapsed. When the power resumes after power failure, the unit will run automatically, and 3 minutes later the compressor starts running.

Note: Cooling only unit don't have the heating mode.

Operation

HEALTH Operation



24°C

1. Unit start

Press the ON/OFF switch

2. Health anion function

Press the "HEALTH" once, " " is displayed, now the air conditioner is operating the healthy function.

3. To Cancel HEALTH Model

Press the "HEALTH" again, then the healthy function stops.

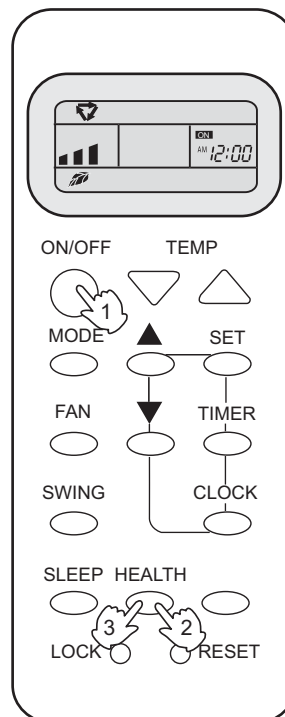

Brief introduction to health anion function

The anion generator in the air conditioner can generate a lot of anion effectively balance the quantity of position and anion in the air and also to kill bacteria and speed up the dust sediment in the room and finally clean the air in the room.

Operation

Timer On/Off Operation



24 °C



Set Clock correctly before starting Timer operation

You can let unit start or stop automatically at following times: Before you wake up in the morning, or get back from outside or after you fall asleep at night.

TIMER ON/OFF

(1) After unit start, select your desired operation mode.
Operation mode will be displayed on LCD.

(2) TIMER mode selection

Press TIMER button to change TIMER mode.

Every time the button is pressed, display changes as follows:



Select your desired TIMER mode (TIMER ON or TIMER OFF) ON or OFF will flash.

(3) Timer setting

Press HOUR Δ / ∇ button.

Δ Every time the button is pressed, time increases 10 min.
If button is kept depressed, time will change quickly.

∇ Every time the button is pressed, time decreases 10 min.
If button is kept depressed, time will change quickly. Time will be shown on LCD. It can be adjusted within 24 hours.

(4) Confirming your setting

After setting correct time, press SET button to confirm, "ON" or "OFF" stops flashing

Time displayed: Unit starts or stops at x hour x min. (TIMER ON or TIMER OFF).

Timer mode indicator on indoor unit lights up.

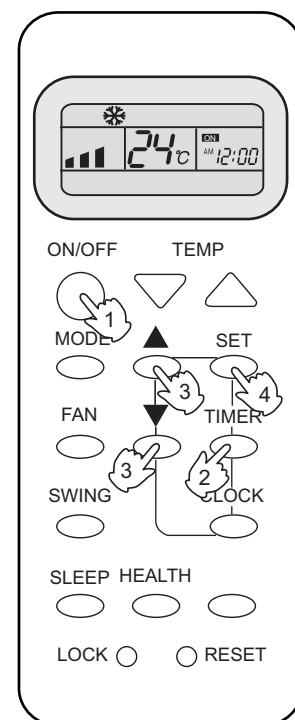

To cancel TIMER mode

Just press TIMER button several times until TIMER mode disappears.

Hints

After replacing batteries or a power failure happens, Time setting should be reset.

Remote controller possesses memory function, when use TIMER mode next time, just press SET button after mode selecting if timer setting is the same as previous one.

Operation

Timer On-Off Operation



24 °C



(1) After unit start, select your desired operation mode
Operation mode will be displayed on LCD.

(2) Press TIMER button to change TIMER mode.
Every time the button is pressed, display changes as follows:



Select TIMER ON-OFF. "ON" will flash.

(3) Time setting for TIMER ON

Press HOUR button.

△ Every time the button is pressed, time increases 10 min.
If button is kept depressed, time will change quickly.

▽ Every time the button is pressed, time decreases 10 min.
If button is kept depressed, time will change quickly.

Time will be shown on LCD.

It can be adjusted within 24 hours.

AM refers to morning and PM to afternoon

(4) Time confirming for TIMER ON

After time setting, press TIMER button to confirm.

"ON" stops blinking, While "OFF" starts blinking.

Time displayed: Unit starts at x hour x min.

(5) Time setting for TIMER OFF

Follow the same procedures in "Time setting for TIMER ON".

(6) Time confirming for TIMER OFF

After time setting, press SET button to confirm, "OFF" stops flashing

Time displayed: Unit stops at X hour X min.

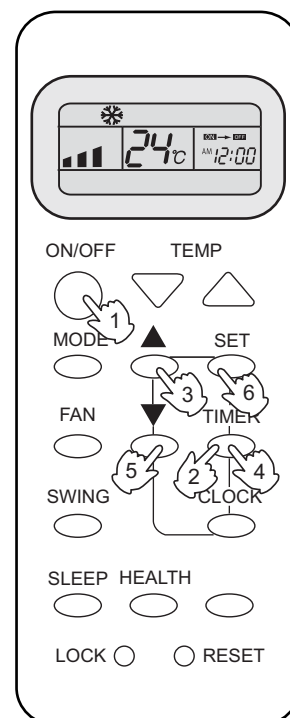

To cancel TIMER mode

- Just press TIMER button several times until TIMER mode disappears.

Operation

Emergency operation and test operation

Emergency Operation:

- Use this operation only when the remote controller is defective or lost.
- When the emergency operation switch is pressed, the " Pi "sound is heard once, which means the start of this operation.
- In this operation, the system automatically selects the operation modes, cooling or heating, according to the room temperature:

Room temperature	Designated temperature	Timer mode	Fan speed	Operation mode
Above 23°C	26°C	No	AUTO	COOL
Below 23°C	23°C	No	AUTO	HEAT

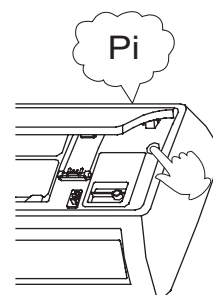

- It is impossible to change the settings of temp.and fan speed,It is also not possible to operate in timer or dry mode.

If an air conditioner is a model for both cooling and heating.

Cooling when the room temperature at the start of operation is above 23°C.

Heating when the room temperature at the start of operation is below 23°C

Test operation:

Test operation switch is the same as emergency switch.

- Use this switch in the test operation when the room temperature is below 16°C, do not use it in the normal operation.
- Continue to press the test operation switch for more than 5 seconds. After you hear the "Pi" sound twice, release your finger from the switch: the cooling operation starts with the air flow speed "Hi".
- After 30 minutes, test operation ends automatically(Only for 22K unit).

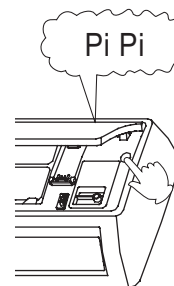



Removal of the restriction of emergency or test operation:

- Press the emergency operation switch once more, or manipulate through the remote controller; the "Pi" sound, the emergency or test operation is terminated.
- When the remote controller is manipulated, it gets the system back to the normal operation mode.

Maintenance

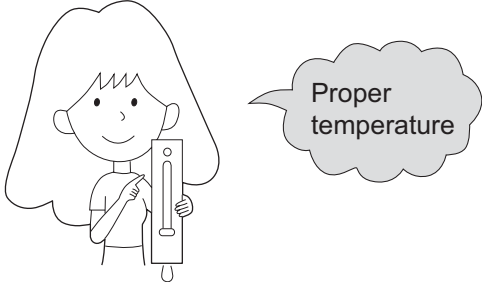
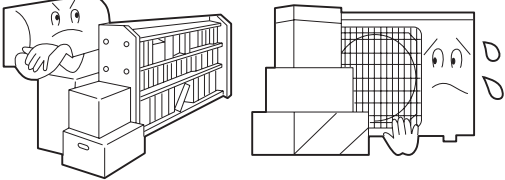
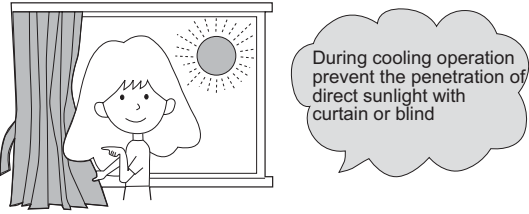
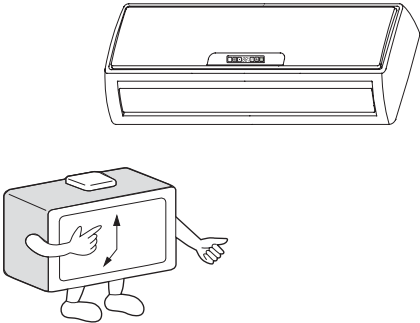
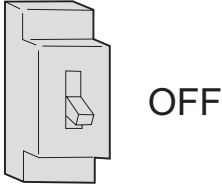
For Smart Use of The Air Conditioner

<p>Setting of proper room temperature</p> 	<p>Do not block the air inlet or outlet</p> 
<p>Close doors and windows during operation</p> 	<p>Use the timer effectively</p> 
<p>If the unit is not to be used for a long time, turn off the power supply main switch.</p> 	<p>Use the louvers effectively</p> 

Maintenance

For Smart Use of The Air Conditioner

⚠ WARNING

Before maintenance, be sure to turn off the system and the circuit breaker.

Remote Controller

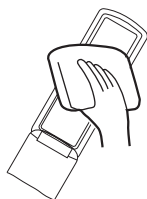

Do not use water, wipe the controller with a dry cloth. Do not use glass cleaner or chemical cloth.

Indoor Body

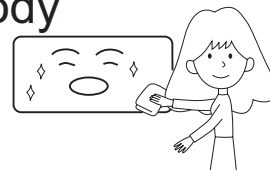

Wipe the air conditioner by using a soft and dry cloth. For serious stains, use a neutral detergent diluted with water. Wring the water out of the cloth before wiping, then wipe off the detergent completely.

Do not use the following for cleaning



Gasoline, benzene, thinner or cleanser may damage the coating of the unit.



Hot water over 40°C (104°F) may cause discoloring or deformation.

Air Filter cleaning

1 Open the inlet grille by pulling it upward.

2 Remove the filter.

Push up the filter's center tab slightly until it is released from the stopper, and remove the filter downward.

3 Clean the filter.

Use a vacuum cleaner to remove dust, or wash the filter with water. After washing, dry the filter completely in the shade.

4 Attach the filter.

Attach the filter correctly so that the "FRONT" indication is facing to the front. Make sure that the filter is completely fixed behind the stopper. If the right and left filters are not attached correctly, that may cause defects.

5 Close the inlet grille.

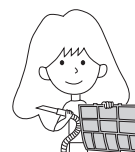
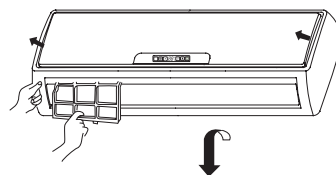

Once every two weeks

Maintenance

Replacement of Air Purifying Filter

1. Open the Inlet Grille

Prop up the inlet grille by using a small device named grille-support which located in the right side of the indoor unit.

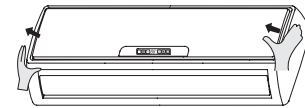

2. Detach the standard air filter

Slide the knob slightly upward to release the filter, then withdraw it.

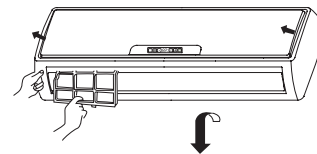

3. Attach Air Purifying Filter

Put air purifying filter appliances into the right and left filter frames.

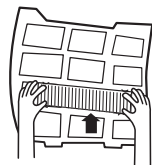

Detach old Air Purifying Filter

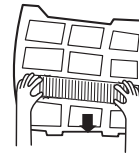

4. Attach the standard air filter (Necessary installation)

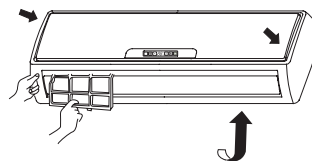

ATTENTION:

The white side of the photocatalyst air purifying filter face outside, and the black side face the unit.

The green side of the bacteria-killing medium air purifying filter face outside, and the white side face the unit.

5. Close the Inlet Grille





Close the Grille surely

NOTE:

- The photocatalyst air purifying filter and the bacteria-killing medium air purifying filter will be used based on real situation.
- The photocatalyst air purifying filter will be solarized in fixed time. In normal family, it will be solarized every 6 months.
- Please keep the bacteria-killing medium air purifying filter in the cool and dry conditions avoid long time directly sunshine when you stop using it, or its ability of sterilization will be reduced.

Trouble shooting

Before asking for service, check the following first.

	Phenomenon	Cause or check points
Normal Performance inspection	<p>The system does not restart immediately.</p> 	<ul style="list-style-type: none"> • When unit is stopped, it won't restart immediately until 3 minutes have elapsed to protect the system. • When the electric plug is pulled out and reinserted, the protection circuit will work for 3 minutes to protect the air conditioner.
	<p>Noise is heard</p> 	<ul style="list-style-type: none"> • During unit operation or at stop, a swishing or gurgling noise may be heard. At first 2-3 minutes after unit start, this noise is more noticeable. (This noise is generated by refrigerant flowing in the system.) • During unit operation, a cracking noise may be heard. This noise is generated by the casing expanding or shrinking because of temperature changes • Should there be a big noise from air flow in unit operation, air filter may be too dirty.
	<p>Smells are generated.</p>	<ul style="list-style-type: none"> • This is because the system circulates smells from the interior air such as the smell of furniture, paint, cigarettes.
	<p>Mist or steam are blown out.</p> 	<ul style="list-style-type: none"> • During COOL or DRY operation, indoor unit may blow out mist. This is due to the sudden cooling of indoor air.
	<p>In dry mode, fan speed can't be changed.</p>	<ul style="list-style-type: none"> • In DRY mode, when room temperature becomes lower than temp.setting+2°C, unit will run intermittently at LOW speed regardless of FAN setting.
Multiple check		<ul style="list-style-type: none"> • Is power plug inserted? • Is there a power failure? • Is fuse blownout?
	<p>Poor cooling</p> 	<ul style="list-style-type: none"> • Is the air filter dirty? Normally it should be cleaned every 15 days. • Are there any obstacles before inlet and outlet? • Is temperature set correctly? • Are there some doors or windows left open? • Is there any direct sunlight through the window during the cooling operation?(Use curtain) • Are there too much heat sources or too many people in the room during cooling operation?

Application temp. range of air conditioner -7°C~43°C.

7. Codes and Description

7.1. Problem Symptoms and Measures

Symptom	Check Item	Details of Measure	Reference page
None of the units operates	Check the power supply.	Check to make sure that the rated voltage is supplied.	----
	Check the indoor PCB	Check to make sure that the indoor PCB is broken	----
Equipment operates but does not cool, or does not heat (only for heat pump)	Diagnosis by service port pressure and operating current.	Check for insufficient gas.	----

Large operating noise and vibrations	Check the installation condition.	Check to make sure that the required spaces for installation (specified in the Technical Guide, etc.) are provided.	----

7.2 Error Codes and Description indoor display

	Code indication	Description	Reference Page
	indoor		
Indoor Malfunction	E1	Room temperature sensor failure	----
	E2	Heat-exchange sensor failure	----
	E4	Indoor EEPROM error	----
	E14	Indoor fan motor malfunction	----

The code indication that is listed above is the main fault

Troubleshooting

Caution

Be sure to turn off power switch before connect or disconnect connector, or else parts damage may be occurred.

E1: Room temperature sensor failure CN604

E2: Heat-exchange sensor failure CN604

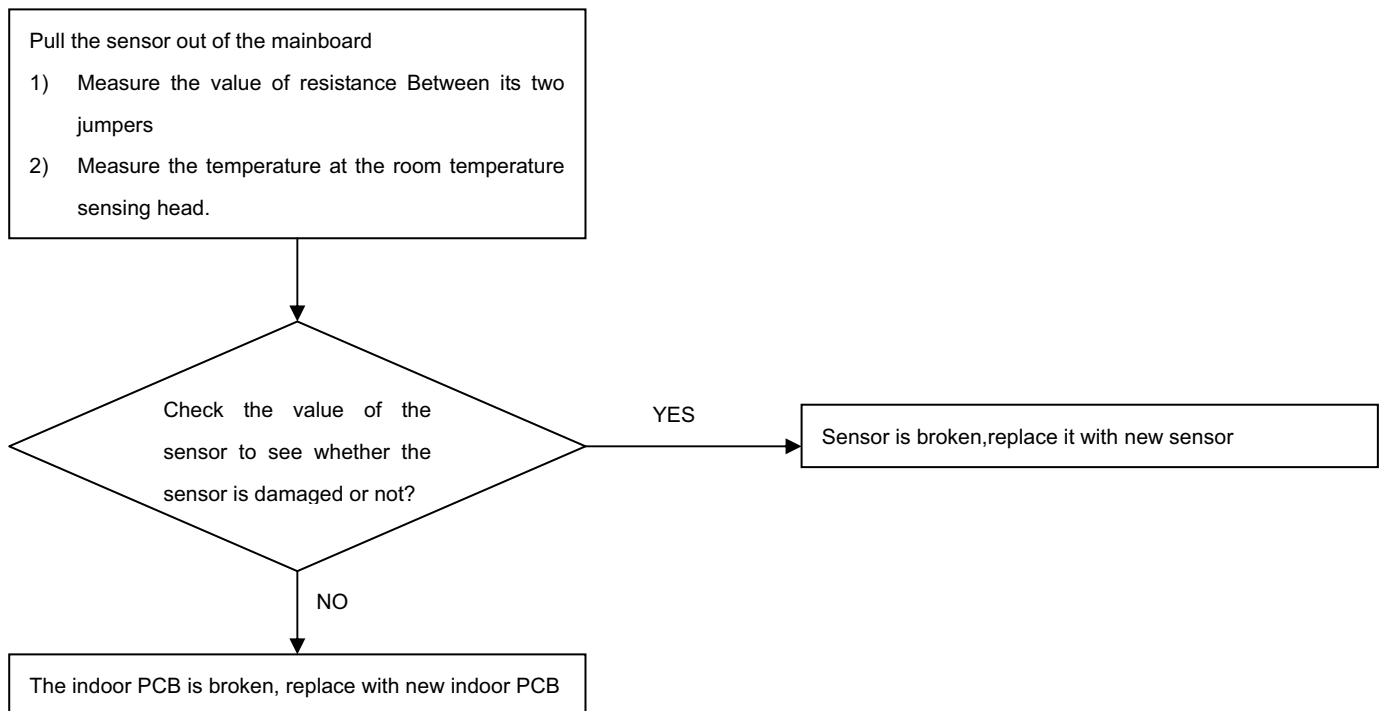

E4: Indoor EEPROM error: Replace the PCB of indoor unit

E14 :Indoor fan motor malfunction



Notes: When the unit is on ,don't pull out or insert the terminal of the motor (CN601), or else The motor would be damaged.

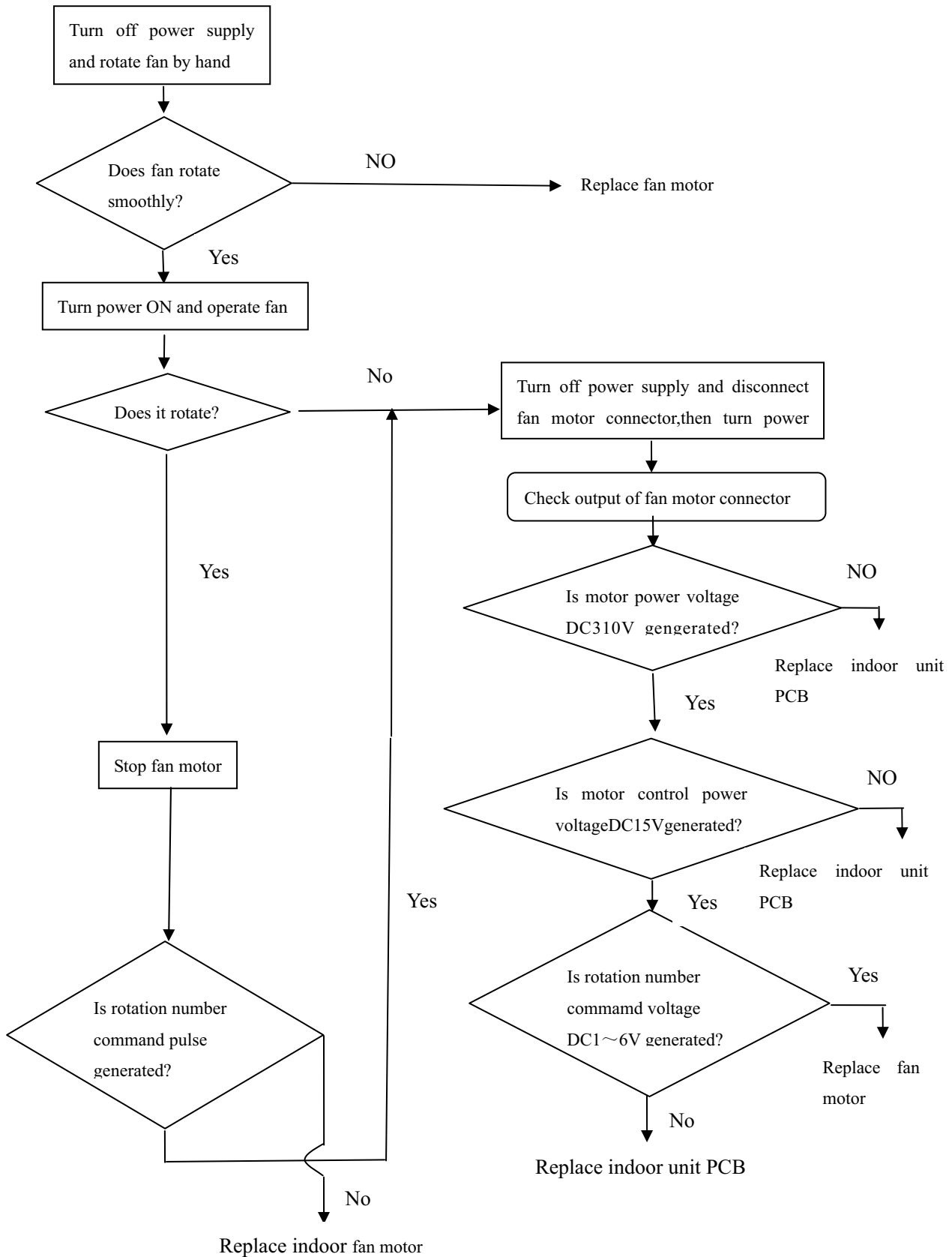

8. Installations





- Read this manual before installation
- Explain sufficiently the operating means to the user according to this manual.

Necessary Tools for Installation

- | | | | |
|----------------------------|---------------------------------|--|-----------|
| 1.Driver | 5.Torque wrench(17mm,22mm,26mm) | 9.Nipper | 12.Reamer |
| 2.Hacksaw | 6.Pipe cutter | 10.Gas leakage detector or soap-and-water solution | |
| 3.Hole core drill | 7.Flaring tool | 11.Measuring tape | |
| 4.Spanner(17, 19 and 26mm) | 8.Knife | | |

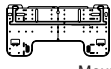
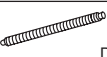
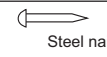
Drawing for the installation of indoor and outdoor units

Accessory parts

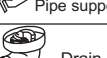
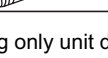
No.	Accessory parts	Number of articles
①	Remote controller	1
②	 R-03 dry battery	2
③	 Mounting plate	1
④	 Drain hose	1
⑤	 $\phi 4 \times 50$ Steel nail, cement	6
⑥	 $\phi 4 \times 25$ Screw Plastic cap	4
⑦	 Cover	1
⑧	 Cushion	4
⑨	 Pipe supporting plate	1
⑩	 Drain-elbow	1

Optional parts for piping

Mark	Parts name
(A)	Non-adhesive tape
(B)	Adhesive tape
(C)	Saddle(L.S) with screws
(D)	Connecting electric cable for indoor and outdoor
(E)	Drain hose
(F)	Heating insulating material
(G)	Piping hole cover

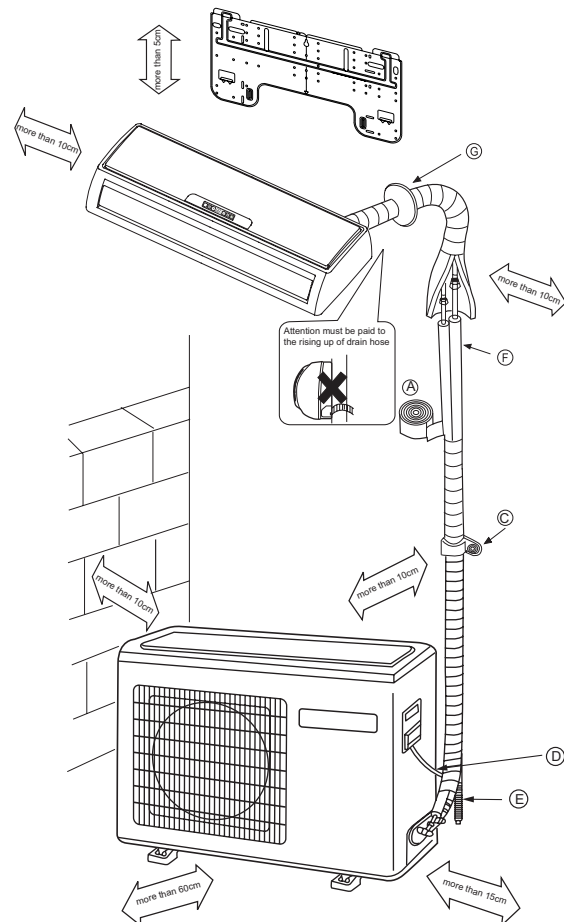
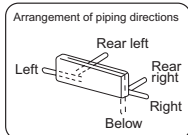

Cooling only unit don't have drain-elbow.

- ※ The marks from (A) to (G) in the figure are the parts numbers.
- ※ The distance between the indoor unit and the floor should be more than 2m.

No.0010515469

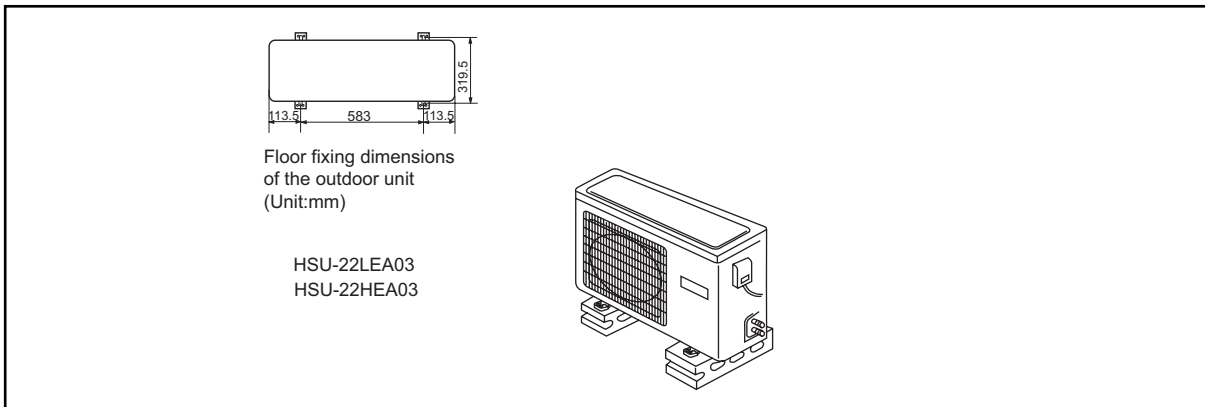

Fixing of outdoor unit

- Fix the unit to concrete or block with bolts ($\phi 10\text{mm}$) and nuts firmly and horizontally.
- When fitting the unit to wall surface, roof or rooftop, fix a supporter surely with nails or wires in consideration of earthquake and strong wind.
- If vibration may affect the house, fix the unit by attaching a vibration-proof mat.

Indoor Unit

Selection of Installation Place

Outdoor Unit

- Place, robust not causing vibration, where the body can be supported sufficiently.
- Place, not affected by heat or steam generated in the vicinity, where inlet and outlet of the unit are not disturbed.
- Place, possible to drain easily, where piping can be connected with the outdoor unit.
- Place, where cold air can be spread in a room entirely.
- Place, nearby a power receptacle, with enough space around. (Refer to drawings).
- Place where the distance of more than 1m from televisions, radios, wireless apparatuses and fluorescent lamps can be left.
- In the case of fixing the remote controller on a wall, place where the indoor unit can receive signals when the fluorescent lamps in the room are lightened.
- Place, which is less affected by rain or direct sunlight and is sufficiently ventilated.
- Place, possible to bear the unit, where vibration and noise are not increased.
- Place, where discharged wind and noise do not cause a nuisance to the neighbors.
- Place, where a distance marked \Leftrightarrow is available as illustrated in the above figure.

Power Source

- Before inserting power plug into receptacle, check the voltage without fail. The power source is the same as the corresponding name plate.
- Install an exclusive branch circuit of the power.
- A receptacle shall be set up in a distance where the power cable can be reached. Do not extend the cable by cutting it.

Selection of pipe

- To this unit, both liquid and gas pipes shall be insulated as they become low temperature in operation.
- Use optional parts for piping set or pipes covered with equivalent insulation material.

	For 22
Liquid pipe (ϕ)	9.52mm(3/8")
Gas pipe (ϕ)	15.88mm(5/8")

Indoor unit

Indoor unit

1. Fitting of the Mounting Plate and Positioning of the wall Hole

When the mounting plate is first fixed

1. Carry out, based on the neighboring pillars or lintels, a proper leveling for the plate to be fixed against the wall, then temporarily fasten the plate with one steel nail.
2. Make sure once more the proper level of the plate, by hanging a thread with a weight from the central top of the plate, then fasten securely the plate with the attachment steel nail.
3. Find the wall hole location A using a measuring tape

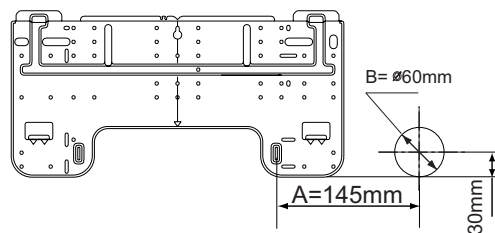

When the mounting plate is fixed side bar and lintel

- Fix to side bar and lintel a mounting bar, which is separately sold, and then fasten the plate to the fixed mounting bar.
- Refer to the previous article, " **When the mounting plate is first fixed** ", for the position of wall hole.

2. Making a Hole on the Wall and Fitting the Piping Hole Cover

- Make a hole of 60 mm in diameter, slightly descending to outside the wall.
- Install piping hole cover and seal it off with putty after installation

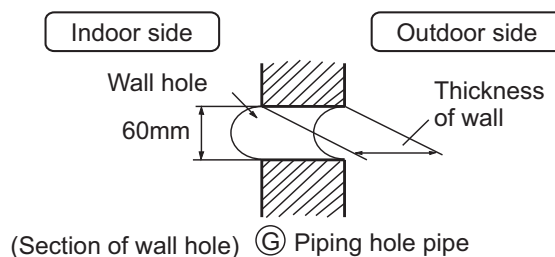

3. Installation of the Indoor Unit

Drawing of pipe

[Rear piping]

- Draw pipes and the drain hose, then fasten them with the adhesive tape

[Left • Left-rear piping]

- In case of left side piping, cut away, with a nipper, the lid for left piping.
- In case of left-rear piping, bend the pipes according to the piping direction to the mark of hole for left-rear piping which is marked on heat insulation materials.

Indoor unit

1. Insert the drain hose into the dent of heat insulation materials of indoor unit.
2. Insert the indoor/outdoor electric cable from backside of indoor unit, and pull it out on the front side, then connect them.
3. Coat the flaring seal face with refrigerant oil and connect pipes.
Cover the connection part with heat insulation materials closely, and make sure fixing with adhesive tape

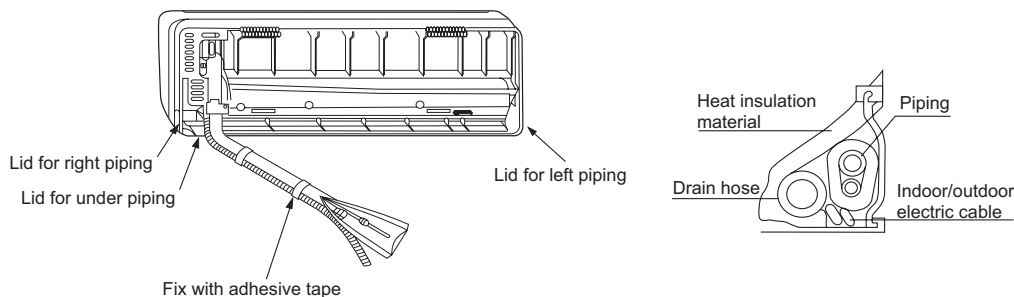

- Indoor/outdoor electric cable and drain hose must be bound with refrigerant piping by protecting tape.

[Other direction piping]

- Cut away, with a nipper, the lid for piping according to the piping direction and then bend the pipe according to the position of wall hole. When bending, be careful not to crash pipes.
- Connect beforehand the indoor/outdoor electric cable, and then pull out the connected to the heat insulation of connecting part specially.

Fixing the indoor unit body

- Hang surely the unit body onto the upper notches of the mounting plate. Move the body from side to side to verify its secure fixing.
- In order to fix the body onto the mounting plate, hold up the body aslant from the underside and then put it down perpendicularly.

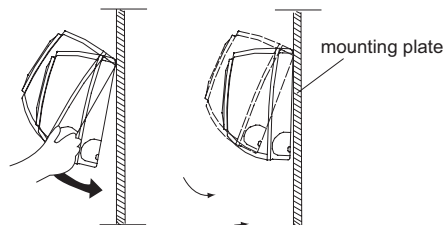

Unloading of indoor unit body

- When you unload the indoor unit, please use your hand to arise the body to leave agraffe, then lift the bottom of the body outward slightly and lift the unit aslant until it leaves the mounting plate.

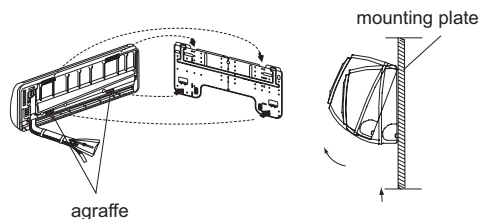

Easily-demount cleaning of indoor unit

Inlet grille can be taken down

Open the inlet grille, press the button of unlock in the left, then push it out of the socket and take out the inlet grille.

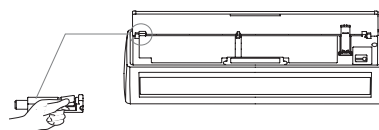

Indoor unit

Connecting the indoor/outdoor Electric Cable

Removing the wiring cover

- Remove terminal cover at right bottom corner of indoor unit, then take off wiring cover by removing its screws.

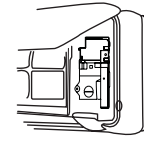

When connecting the cable after installing the indoor unit

- Insert from outside the room cable into left side of the wall hole, in which the pipe has already existed.
- Pull out the cable on the front side, and connect the cable making a loop.

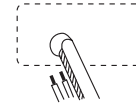

When connecting the cable before installing the indoor unit

- Insert the cable from the back side of the unit, then pull it out on the front side.
 - Loosen the screws and insert the cable ends fully into terminal block, then tighten the screws.
 - Pull the cable slightly to make sure the cables have been properly inserted and tightened.
 - After the cable connection, never fail to fasten the connected cable with the wiring cover.
- Note: When connecting the cable, confirm the terminal number of indoor and outdoor units carefully. If wiring is not correct, proper operation can not be carried out and will cause defect.
- If the supply cord is damaged, it must be replaced by the manufacturer or its service agent or a similar qualified person. The type of connecting wire is H05/07RN-F or 245IEC57(YZW).
 - If the fuse on PC board is broken please change it with the type of T. 3.15A/250V.
 - The wiring method should be in line with the local wiring standard.
 - After installation, the power plug should be easily reached.
 - A breaker should be incorporated into fixed wiring. The breaker should be all-pole switch and the distance between its two contacts should be not less than 3mm.

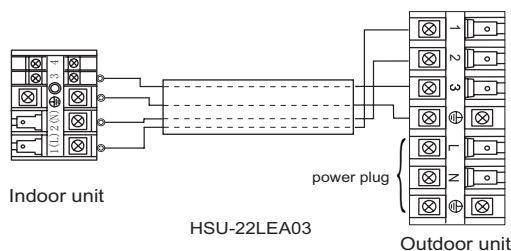
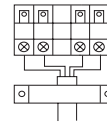
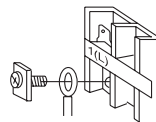
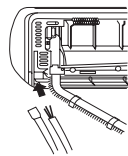

connecting wiring: -mod 22: $\geq 4G0.75mm^2$ Power cable: -mod 22: $\geq 3G2.5mm^2$

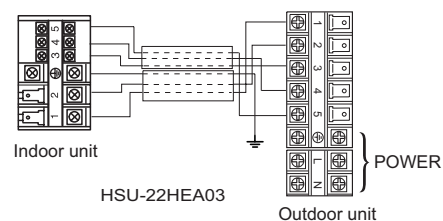

connecting wiring: -mod 22: $\geq 6G0.75mm$ Power cable: -mod 22: $\geq 3G2.5mm^2$

Outdoor unit

Outdoor unit

1. Installation of Outdoor Unit

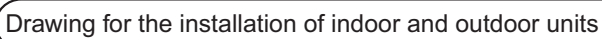
Install according to 

2. Connection of pipes

- To bend a pipe, give the roundness as large as possible not to crush the pipe
- Connecting the pipe of gas side first makes working easier.
- The max vertical distance between the indoor unit and the outdoor unit is 5 m.

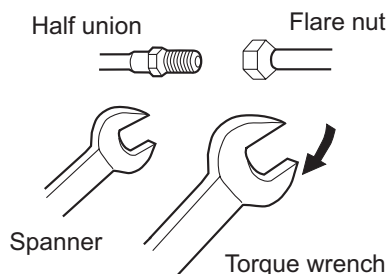

Forced fastening without careful centering may damage the threads and cause a leakage of gas.

Pipe Diameter (ϕ)	Fastening torque
Liquid side 6.35mm(1/4")	18N.m
Liquid side 9.52mm(3/8")	40N.m
Gas side 9.52mm(3/8")	42N.m
Gas side 12.7mm(1/2")	50N.m
Gas side 15.88mm(5/8")	60N.m

Be careful that matters, such as wastes of sands, etc. shall not enter the pipe.

3. Connection

- Use the same method on indoor unit. Loosen the screws on terminal block and insert the plugs fully into terminal block, then tighten the screws.
- Insert the cable according to terminal number in the same manner as the indoor unit.
- If wiring is not correct, proper operation can not be carried out and controller may be damaged.
- Fix the cable with a clamp.

4. Attaching Drain-Elbow

- If the drain-elbow is used, please attach it as figure. (Note: Only for heat pump unit.)

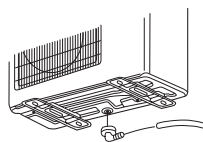

Outdoor unit

5. Purging Method:

Push the air out of the indoor unit and piping as follows:

- (1) Remove the valve cap on 2-way valve in outdoor unit.
- (2) Loosen by 1/2 turn the flare nut of gas pipe, which is connected to 3-way valve.
- (3) Loosen 2-way valve by 90° using hexagon wrench, and after approx. 10 sec tighten it up. Gas comes out through flare nut on wide pipe. If no gas is discharged, tighten flare nut with specified torque.
- (4) Open 2-way and 3-way valves using specified torque.
- (5) Tighten the caps on the valves with specified torque.

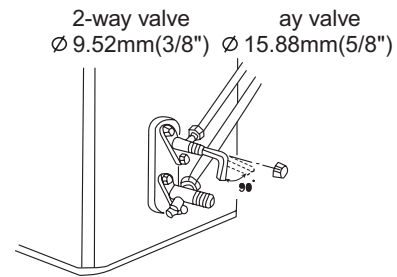

HSU-22LEA03
HSU-22HEA03

	Tighten torque N.m
Valve rod	7-9
Valve cap	20-25

- When connecting pipe exceeds 5 meters, 20g or 60g (only for 22k) refrigerant shall be added per exceeding meter. Charge according to the following list.

	for 22k		
Piping length	5m	7m	10m
Additional amount	No need	120g	300g

- Note: When extending piping, air inside piping shall be removed by using external refrigerant gas, charge according to the following list.

Brand new outdoor unit is charged 50g or 80g (only for 22k) more refrigerant than regulated weight. Only for first installation, this extra 50g or 80g (only for 22k) can be used to purge air in pipes.

- ★ 1 During this procedure, 50g or 80g (only for 22k) refrigerant will be discharged in piping. (This must be strictly controlled within 90° and 10 sec.)

1. Power Source Installation

- The power source must be exclusively used for air conditioner. (Over 10A)
- In the case of installing an air conditioner in a moist place, please install an earth leakage breaker.
- For installation in other places, use a circuit breaker as far as possible.

2. Cutting and Flaring Work of Piping

- Pipe cutting is carried out with a pipe cutter and burs must be removed.
- After inserting the flare nut, flaring work is carried out.

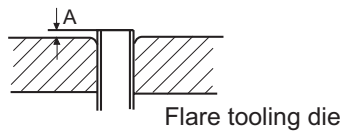

	Pipe diameter(φ)	Size A(mm)
Liquid side	6.35mm(1/4")	0.8~1.5
Liquid side	9.52mm(3/8")	1.0~1.8
Gas side	9.52mm(3/8")	1.0~1.8
Gas side	12.7mm(1/2")	1.2~2.0
Gas side	15.88mm(5/8")	1.4~2.2

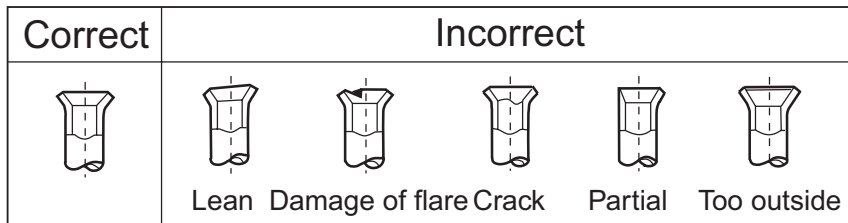

3. On Drainage

Please install the drain hose so as to be downward slope without fail.
Please don't do the drainage as shown below.

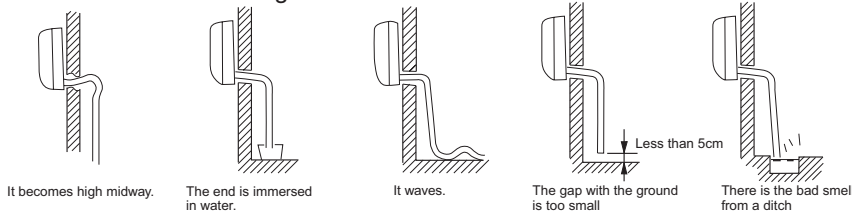

- Please pour water in the drain pan of the indoor unit, and confirm that drainage is carried out surely to outdoor.
- In case that the attached drain hose is in a room, please apply heat insulation to it without fail.

Check for Installation and Test Run

- Please kindly explain to our customers how to operate through the instruction manual.

Check Items for Test Run

Put check mark ✓ in boxes

- | | | |
|--|--|--|
| <input type="checkbox"/> Gas leak from pipe connecting? | <input type="checkbox"/> Is drainage securely carried out? | <input type="checkbox"/> Is the lamp normally lighting? |
| <input type="checkbox"/> Heat insulation of pipe connecting? | <input type="checkbox"/> Is the earth line securely connected? | <input type="checkbox"/> Are cooling and heating (when in heat pump) performed normally? |
| <input type="checkbox"/> Are the connecting wirings of indoor and outdoor firmly inserted to the terminal block? | <input type="checkbox"/> Is the indoor unit securely fixed? | <input type="checkbox"/> Is the operation of room temperature regulator normal? |
| <input type="checkbox"/> Is the connecting wiring of indoor and outdoor firmly fixed? | <input type="checkbox"/> Is power source voltage abided by the code? | |
| | <input type="checkbox"/> Is there any noise? | |

9. Removal Procedure

Indoor unit

9.1 Removal of Air Filter

Procedure

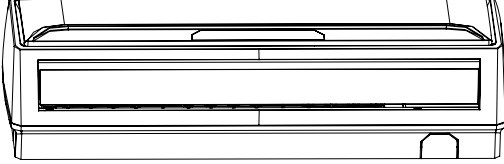
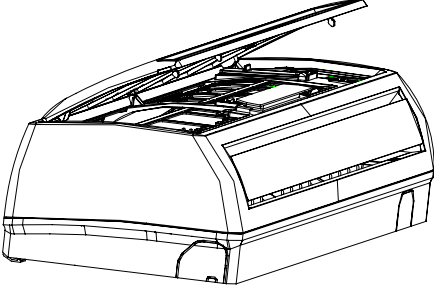

Warning Be sure to wait 10 minutes or more after turning off all power supplies before disassembling work.

Step	Procedure	Points
1. Features		
2. Remove the air filters.	<p>1 Hold the front panel by the tabs on the both sides and lift it until it stops with a click.</p>	
		

9.2 Removal of Front Grille

Procedure



Warning Be sure to wait 10 minutes or more after turning off all power supplies before disassembling work.

Step	Procedure	Points
<p>1. Remove the front panel.</p> <p>1 Open the front panel to the horizontal position. Release the both sides pivots and remove the front panel.</p>	<p style="text-align: center;">3-hooks</p>	<ul style="list-style-type: none"> ■ Start the removal procedure of front grille when the panels are closed. ■ Slide the front panel side to side to release each axis. ■ When assembling, align the right and left axes with grooves in turn and insert them to the end.

9.3 Removal of Horizontal Blade

Procedure

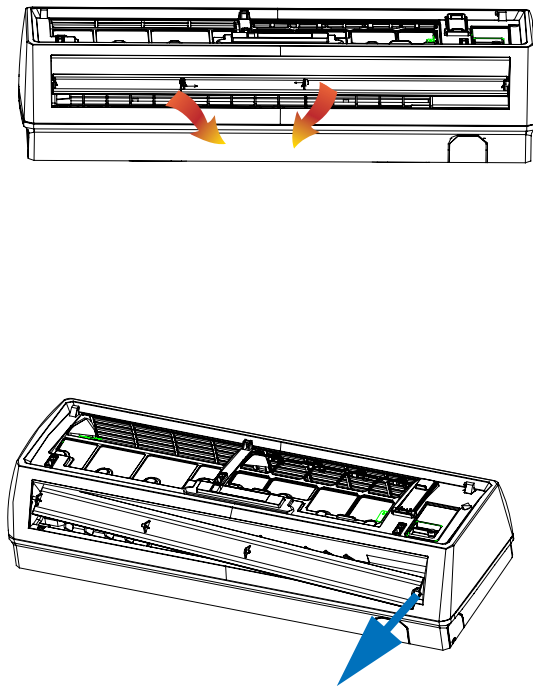
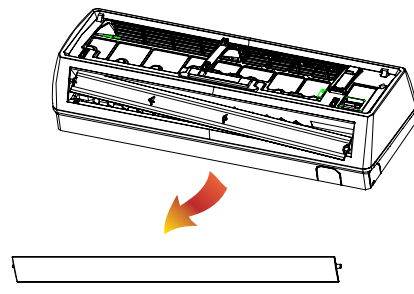

Warning Be sure to wait 10 minutes or more after turning off all power supplies before disassembling work.

Step	Procedure	Points
1. Remove the horizontal blade.		<ul style="list-style-type: none"> ■ The horizontal blade is single.
1	<p>Release the center pivot.</p> 	<ul style="list-style-type: none"> ■ Installation procedure <ol style="list-style-type: none"> 1. Since key pattern hook is provided, rotate the blade and fit it to the left pivot first. 2. Fit the blade to the right pivot. 3. Fit the blade to the center pivot.
2	<p>Bend the horizontal blade slightly and remove it.</p> 	

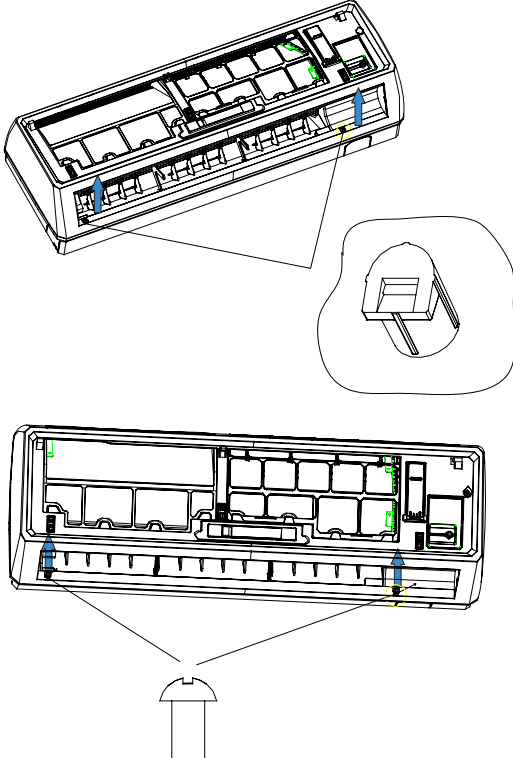
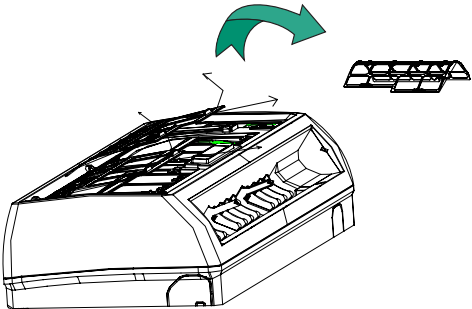
Step	Procedure	Points
	<p data-bbox="204 360 480 450">Pull the two bolt dowels and Loosen the marked two screws</p>  <p data-bbox="217 1339 469 1397">Pull the air filters and remove them</p> 	<ul style="list-style-type: none"> <li data-bbox="1094 1547 1444 1637">■ When assembling, install the front grille horizontally so as not to stuff the flap inside. <li data-bbox="1094 1644 1444 1733">■ When assembling, make sure the three hooks are caught properly.

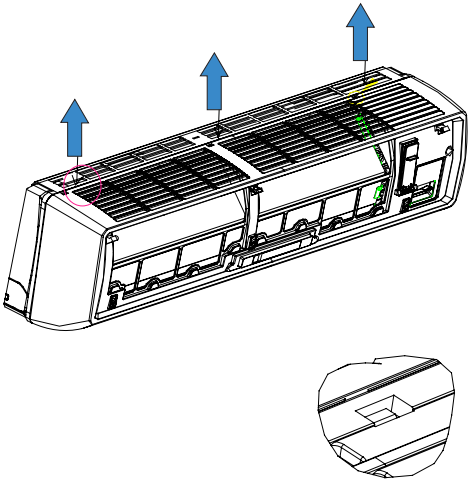
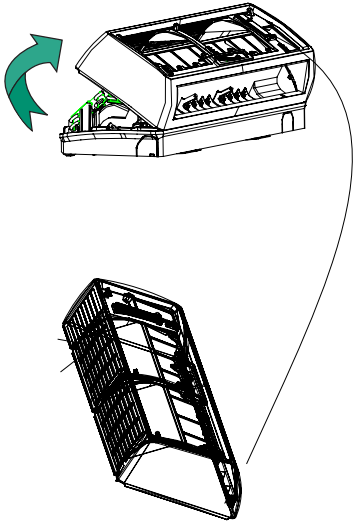
Step	Procedure	Points
Release the marked three hooks.		<ul style="list-style-type: none"> ■ When assembling, install the front grille horizontally so as not to stuff the flap inside. ■ When assembling, make sure the three hooks are caught properly.
Pull the front grille out horizontally and remove it.		

9.4 Removal of Drain pan

Procedure

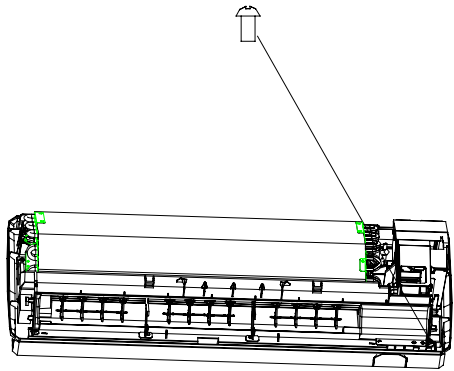
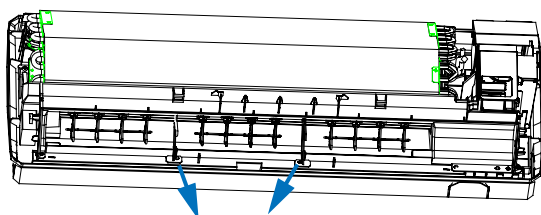
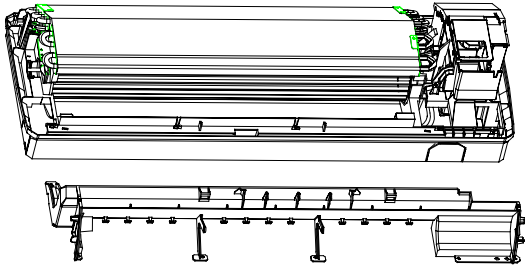

Warning Be sure to wait 10 minutes or more after turning off all power supplies before disassembling work.

Step	Procedure	Points
<p>1. Remove the Drain pan</p>	<p>1 Loosen the marked screws</p>  <p>2 Pull the two chips out from the frame</p>  <p>3 Pull out the drain pan</p> 	

9.5 Removal of Vertical Blades and Swing Motor

Procedure



Warning Be sure to wait 10 minutes or more after turning off all power supplies before disassembling work.

Step	Procedure	Points
<p>■ Remove the assembly of the outlet grille.</p>		
<p>1. Remove the vertical blades.</p>		
<p>1 Push the hooks on the back of the vertical blades and remove.</p>		

9.6 Removal of Electrical Box

Procedure

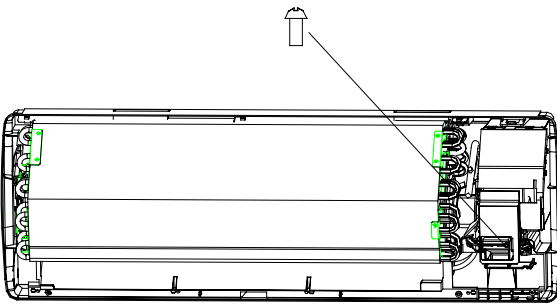
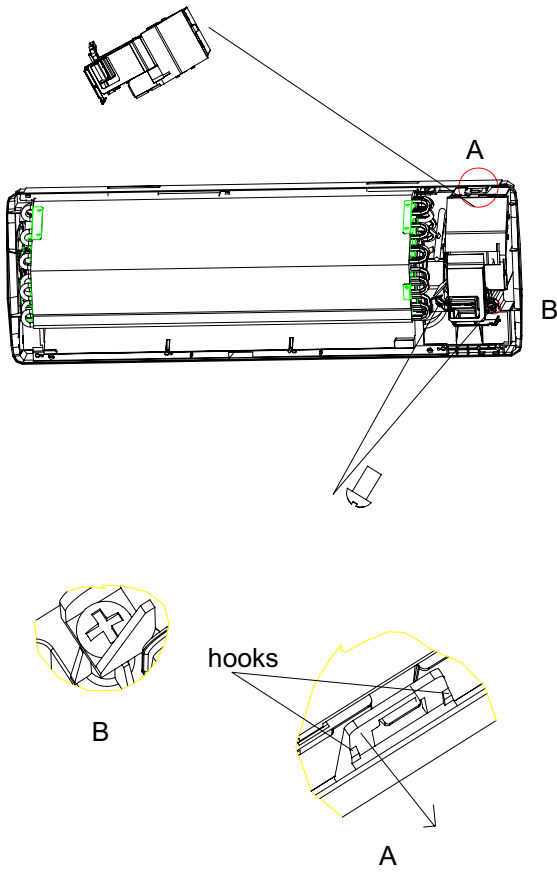

Warning Be sure to wait 10 minutes or more after turning off all power supplies before disassembling work.

Step	Procedure	Points
<p>■ Remove the front grille. 1. Remove the electrical box.</p>		<p>■ Discharge the static electricity from your body before touching the electrical parts like signal receiver PCB. It may cause malfunction of PCB.</p>
<p>1 Loosen the screw marked and pull the electrical control box cover out</p> <p>2 Loosen the two marked screw and then loosen the hooks marked the control box can be pulled out</p>		<p>■ When assembling, insert the left hook of the drip proof plate into the hem plate of the heat exchanger.</p>

9.7 Removal of Heat Exchanger

Procedure

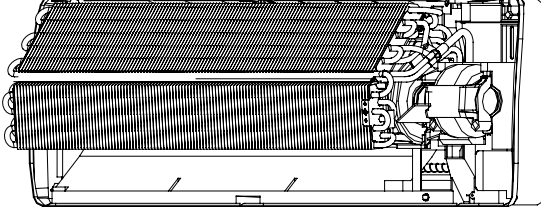
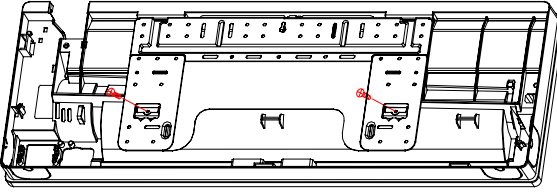
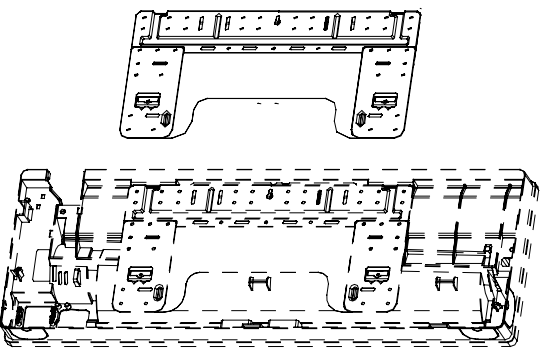

Warning Be sure to wait 10 minutes or more after turning off all power supplies before disassembling work.

Step	Procedure	Points
		<ul style="list-style-type: none"> ■ You can detach the indoor unit without removing the assembly of the outlet grille.
1	<p>Loosen the screws fixed to the installation plate.</p> 	<p> Caution If gas leaks, repair the spot of leaking, then collect all refrigerant from the unit. After conducting vacuum drying, recharge proper amount of refrigerant.</p>
2	<p>Loosen the marked hooks</p> 	<p> Caution Do not contaminate any gas (including air) other than the specified refrigerant (R410A), into refrigerant cycle. (Contaminating of air or other gas causes abnormal high pressure in refrigerating cycle, and this results in pipe breakage or personal injuries.)</p>
3	<p>Loosen the marked screws and remove mounting plate</p> 	<ul style="list-style-type: none"> ■ Pay attention so that the residual water in the drain will not make the floor wet. ■ In case that a drain hose is buried inside a wall, remove it after the drain hose in the wall is pulled out. ■ Use two wrenches to disconnect pipes. ■ When disconnecting pipes, cover every nozzle with caps so as not to let dust and moisture in.

Step	Procedure	Points
1	Release the hooks	
2	Release the hook from the back side. Lift up the lower part of the fixture plate and remove it.	
6	Remove the heat exchanger	

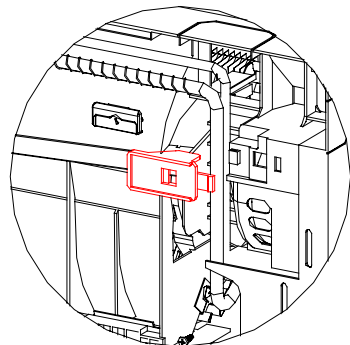
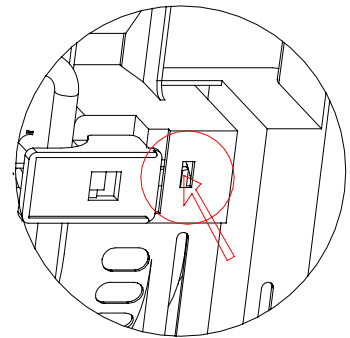
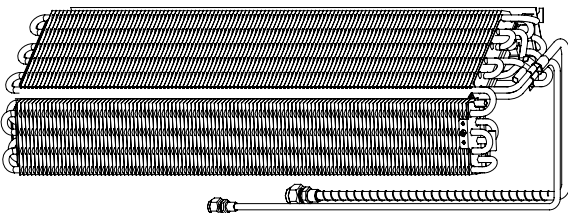
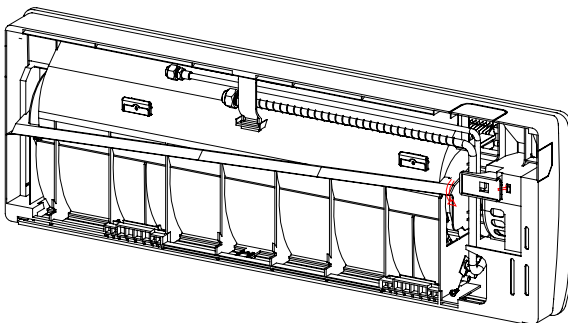
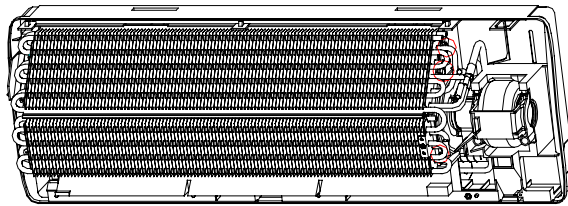
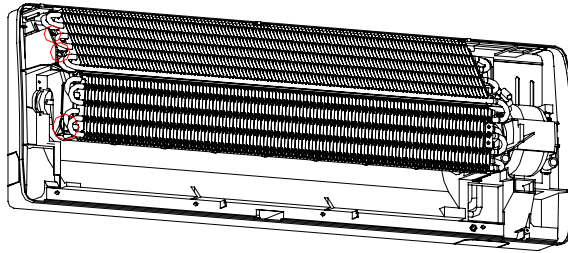

9.8 Removal of Fan Rotor and Fan Motor

Procedure

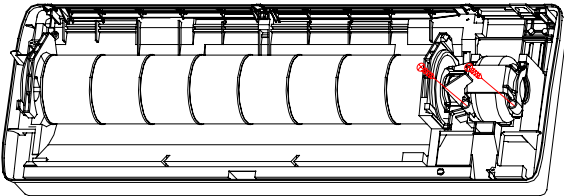
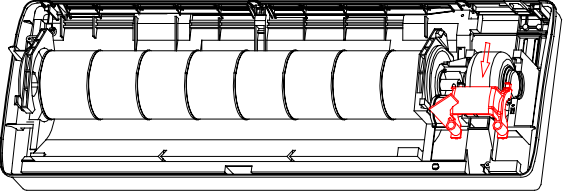
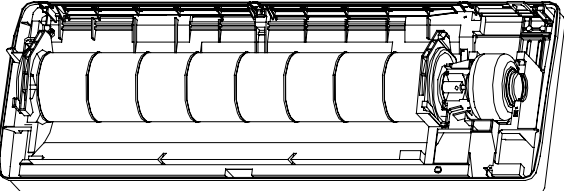
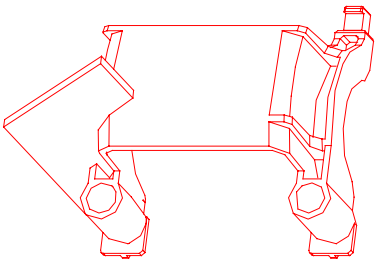

Warning Be sure to wait 10 minutes or more after turning off all power supplies before disassembling work.

Step	Procedure	Points
1. Remove the right side plate.		
1 Loosen the 2 screws.		
2 Remove the fixing plate.		
		
		

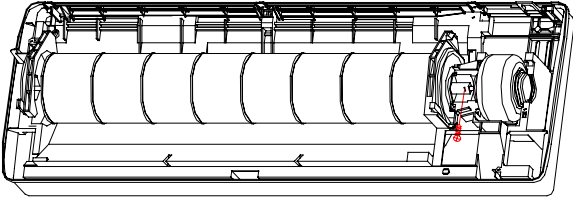
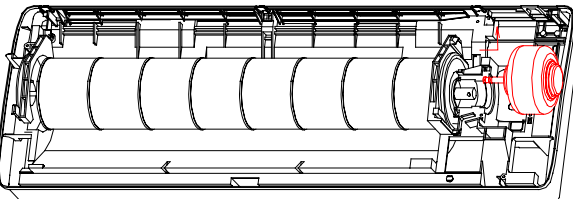
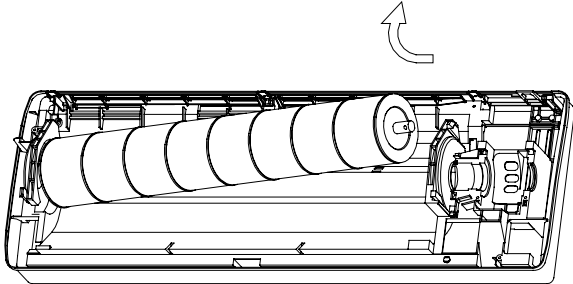
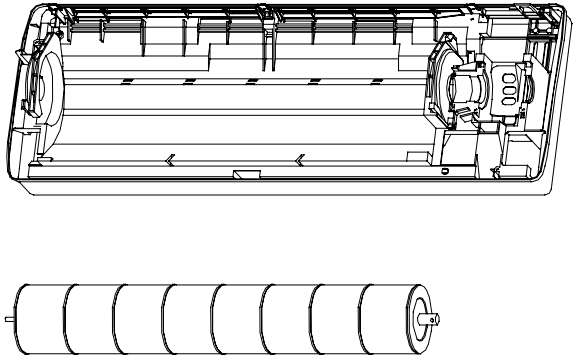
Step	Procedure	Points
3. Remove the fan.		
1	<p>Loosen the marked screw.</p> 	
2	<p>Lift up the right part of the fan motor and slide it to the rightward to remove.</p> 	
3	<p>Lift up the right part of the fan and remove it</p> 	
		

Outdoor unit

9.9 Removal of outdoor panel HSU-22L/HEA03

Procedure



Warning Be sure to wait 10 minutes or more after turning off all power supplies before disassembling work.

Step	Procedure	Points
1. Features	<div data-bbox="502 427 1050 987" data-label="Image"> </div> <div data-bbox="215 1131 446 1276" data-label="Text"> <p>Loosen the service cover screw and remove the service cover.</p> </div> <div data-bbox="494 1064 1077 1523" data-label="Image"> </div> <div data-bbox="207 1646 446 1713" data-label="Text"> <p>Loosen the 4 screws and lift the top panel</p> </div> <div data-bbox="534 1590 981 2060" data-label="Image"> </div>	

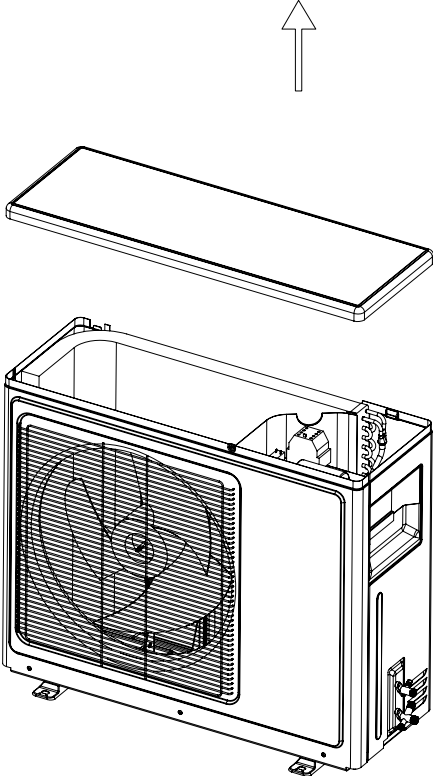
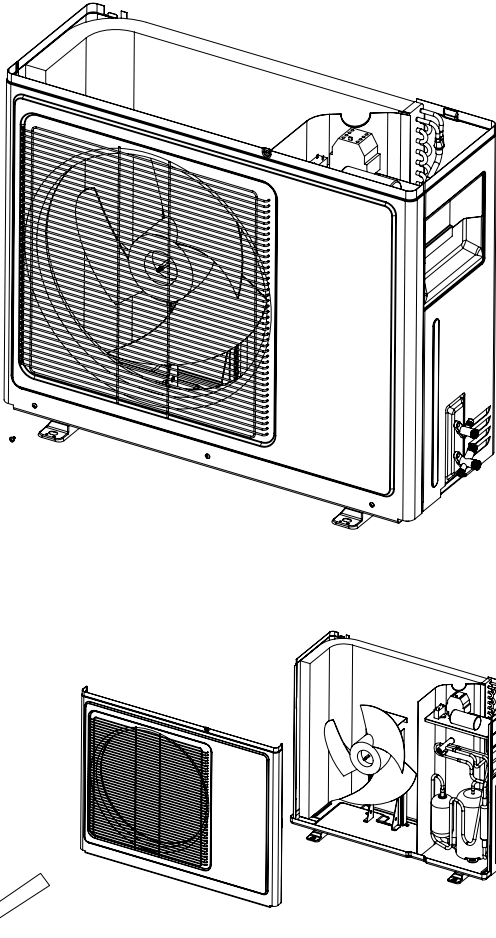
Step	Procedure	Points
	 <p data-bbox="212 1133 456 1200">Loosen the screws of the panel.</p>  <p data-bbox="220 1727 448 1794">Pull and remove the front panel.</p>	

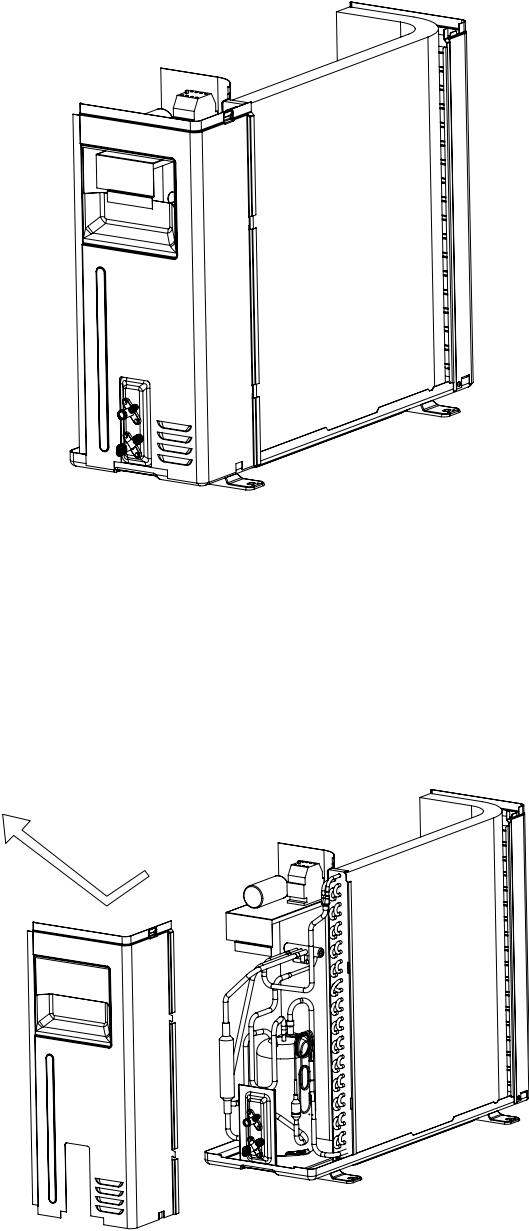
Step	Procedure	Points
	 <p>The diagram illustrates the removal of the indoor unit cover. The top illustration shows the cover being lifted away from the main unit. The bottom illustration shows the cover being pushed back into place, with an arrow indicating the direction of movement.</p>	

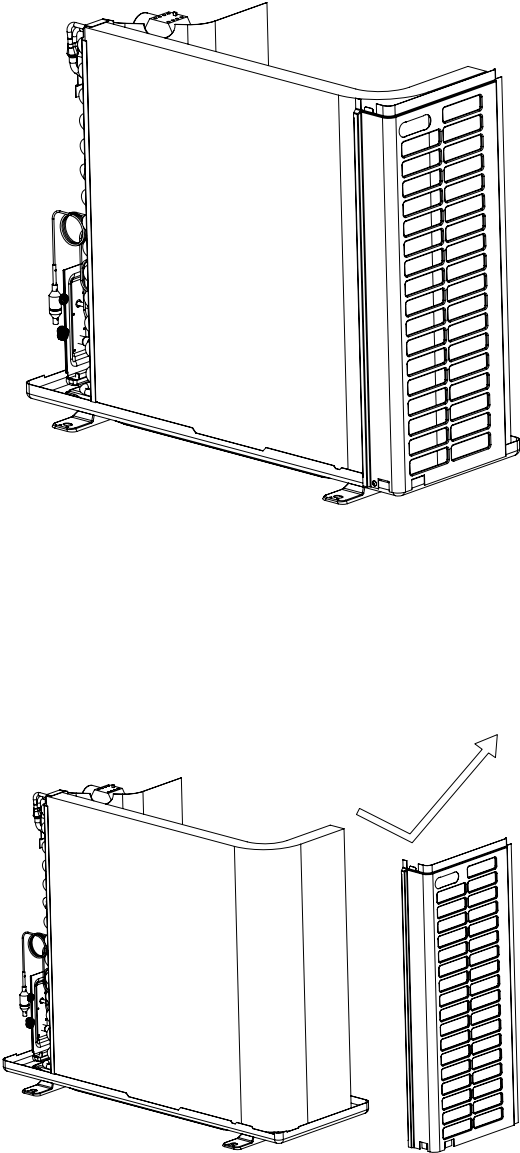
Step	Procedure	Points
	 <p>The diagram illustrates the removal of the front grille from the indoor unit. The top illustration shows the indoor unit with the front grille attached. The bottom illustration shows the indoor unit with the front grille removed, indicated by an arrow pointing to the separated grille.</p>	

9.10 Removal of Electrical Box

Procedure

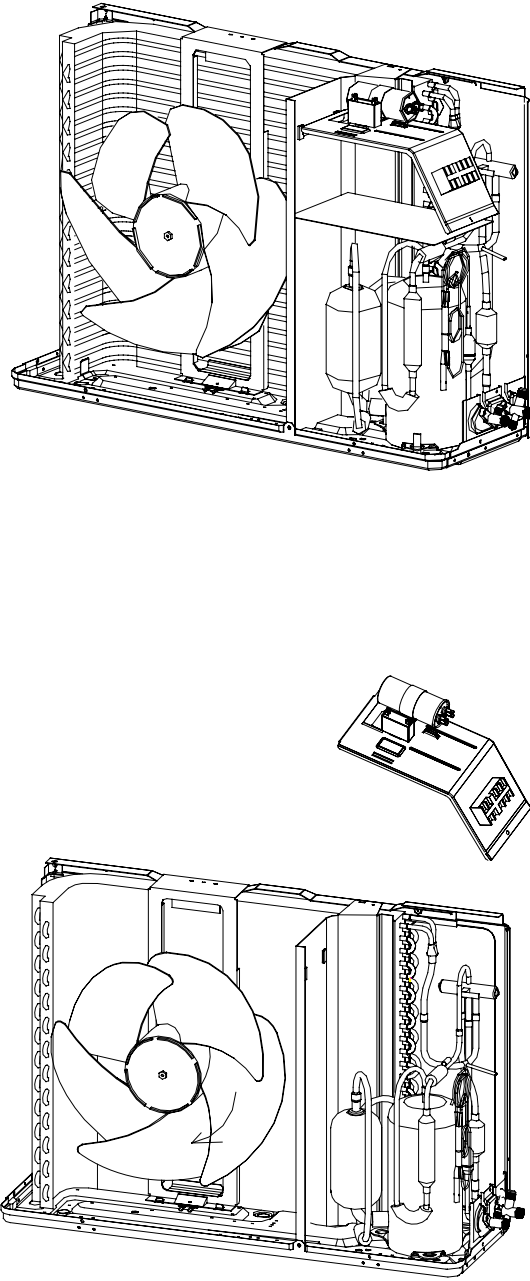

Warning Be sure to wait 10 minutes or more after turning off all power supplies before disassembling work.

Step	Procedure	Points
<p>1 Remove the fixing screws Then lift the electrical box</p>		

9.11 Removal of Fan and Fan Motor

Procedure

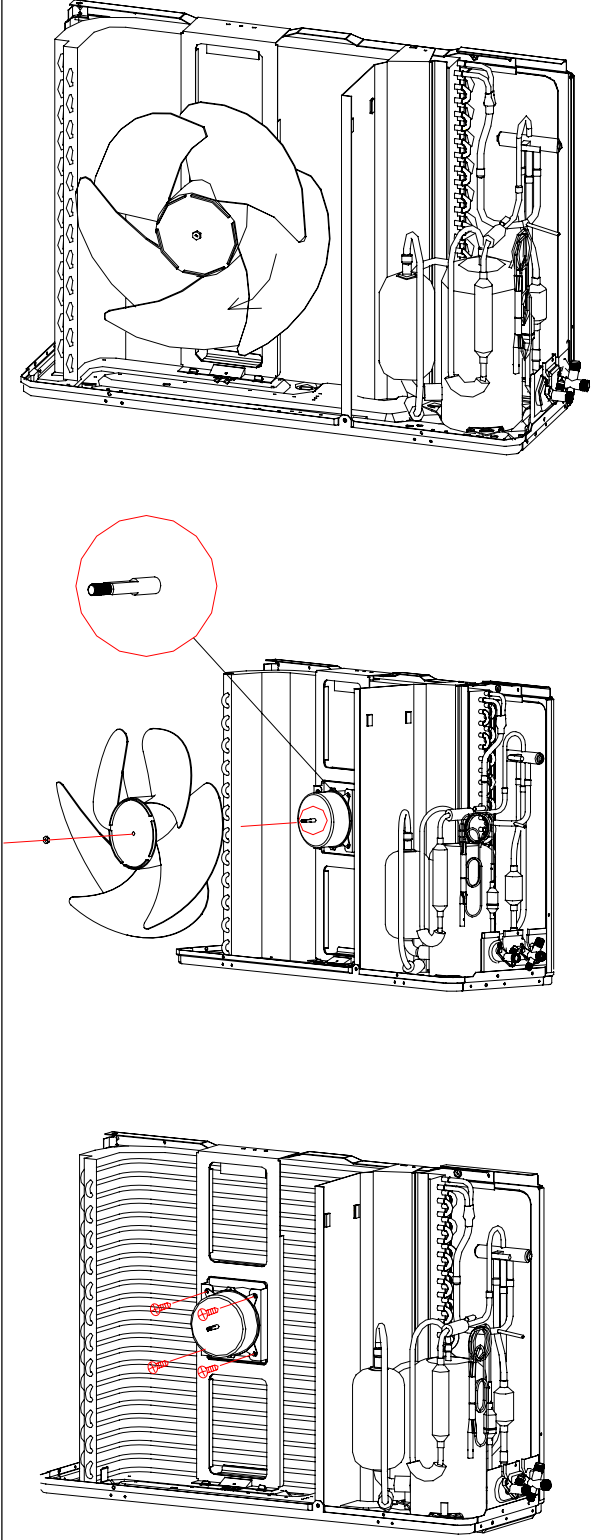
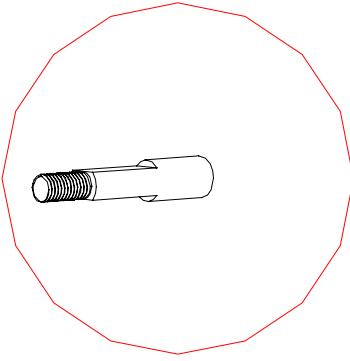

Warning Be sure to wait 10 minutes or more after turning off all power supplies before disassembling work.

Step	Procedure	Points
1	<p>Loosen the fixing screw and remove the fan</p> 	 <ul style="list-style-type: none"> ■ Put the lead wire through the back of the motor when assembling. (so as not to be entangled with the propeller fan)

9.12 Removal of fan motor bracket and partition

Procedure

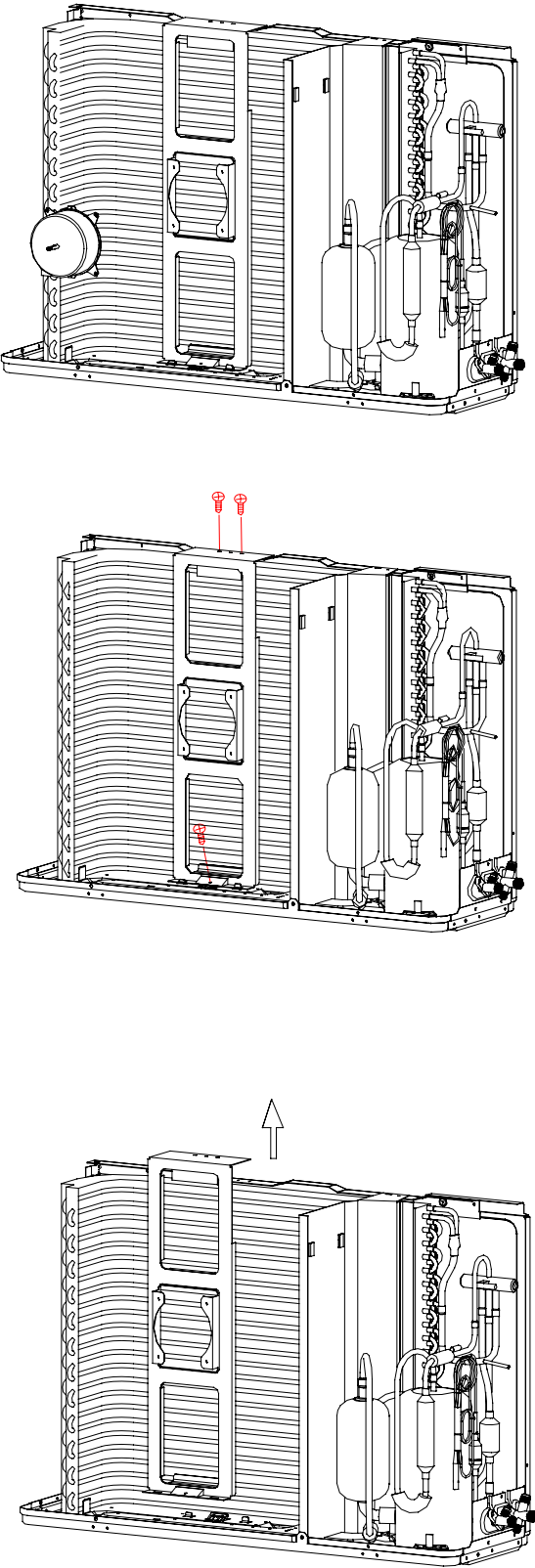

Warning Be sure to wait 10 minutes or more before disassembling work.

Step	Procedure	Points
1	<p>Loosen the fixing screws and lift the fan motor bracket .</p> 	

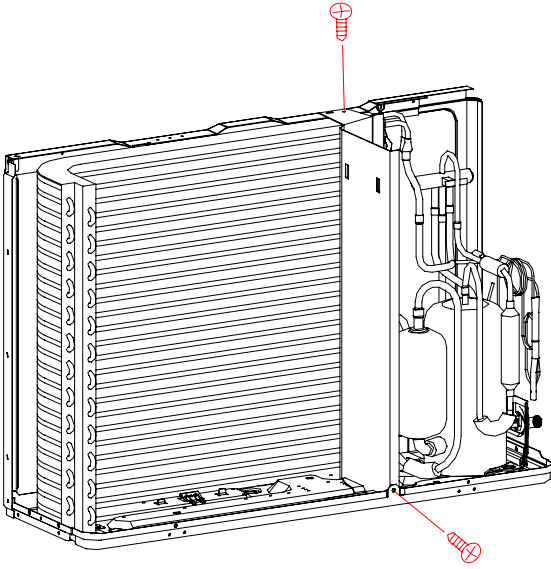
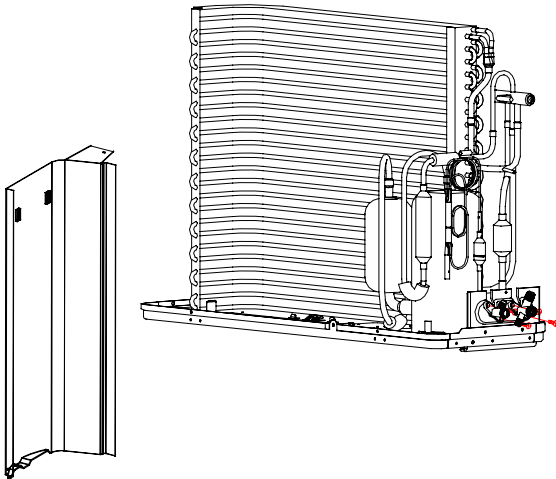
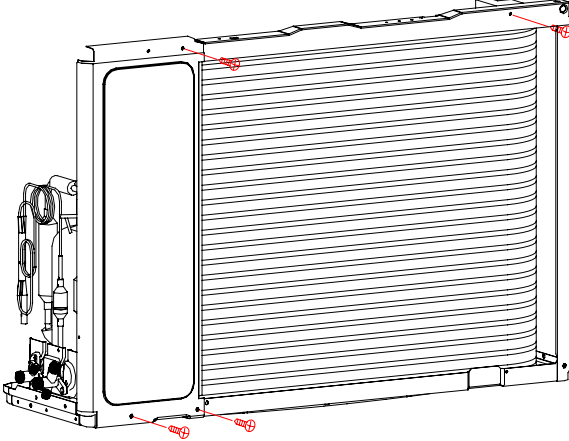
Step	Procedure	Procedure	Points
3	Loosen the 2 screws		
4	The partition plate has a hook on the lower side. Lift and pull the partition plate to remove.		<ul style="list-style-type: none"> ■ When assembling ,fit the lower hook into the bottom frame .
5	Loosen the marked fixing screws		

9.13 Removal of compressor and heat exchanger

Procedure

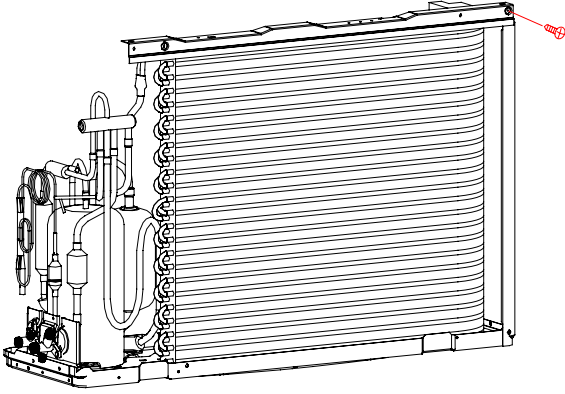
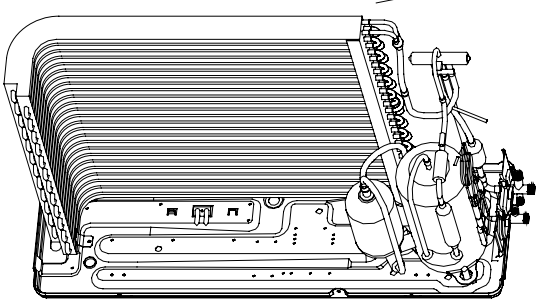
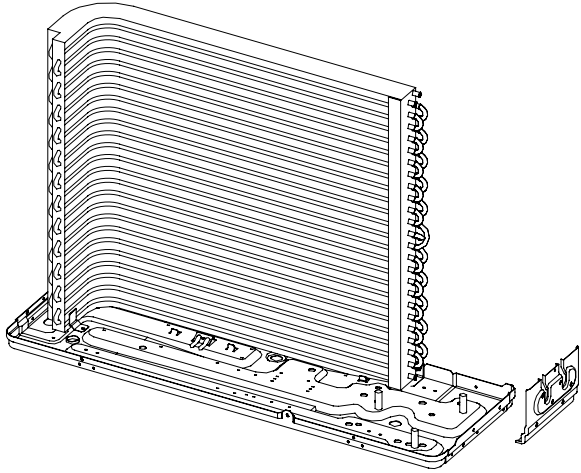

Warning Be sure to wait 10 minutes or more after tu before disassembling work.

Step	Procedure	Procedure	Points
1	Loosen the marked screw .		
2	Cut down the conecting pipe and pull out the compressor and remove the valve bracket .	 	

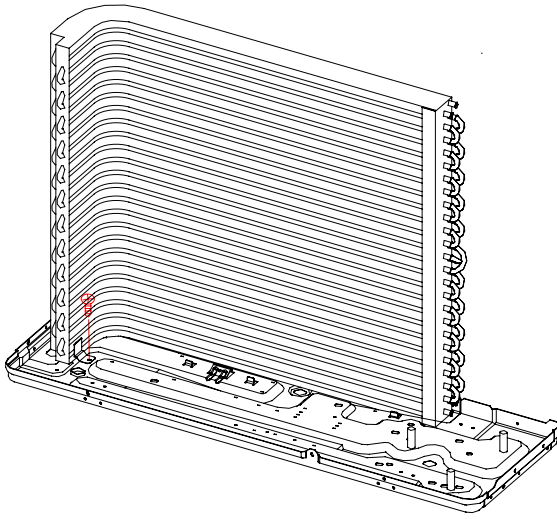
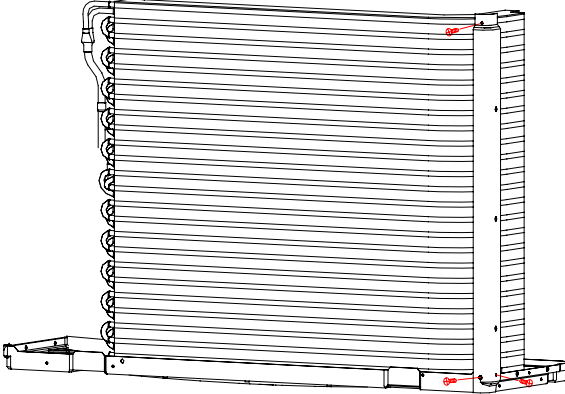
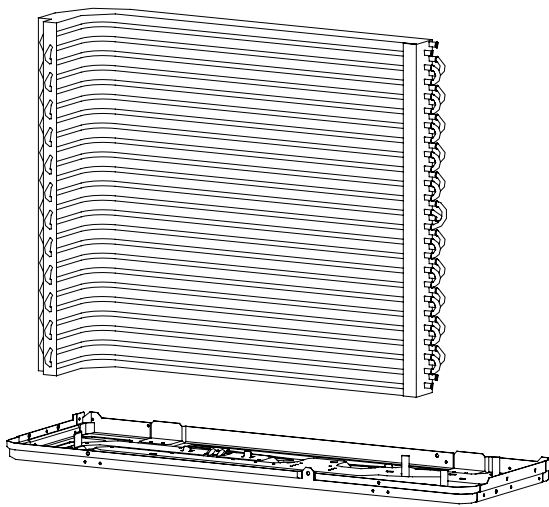
Step		Procedure	Points
3	Loosen the marked fixing screw .		
4	Loosen the fixing hook and remove the heat exchanger .	 	

10. Appendix

10.1 Piping Diagrams

Cooling mode

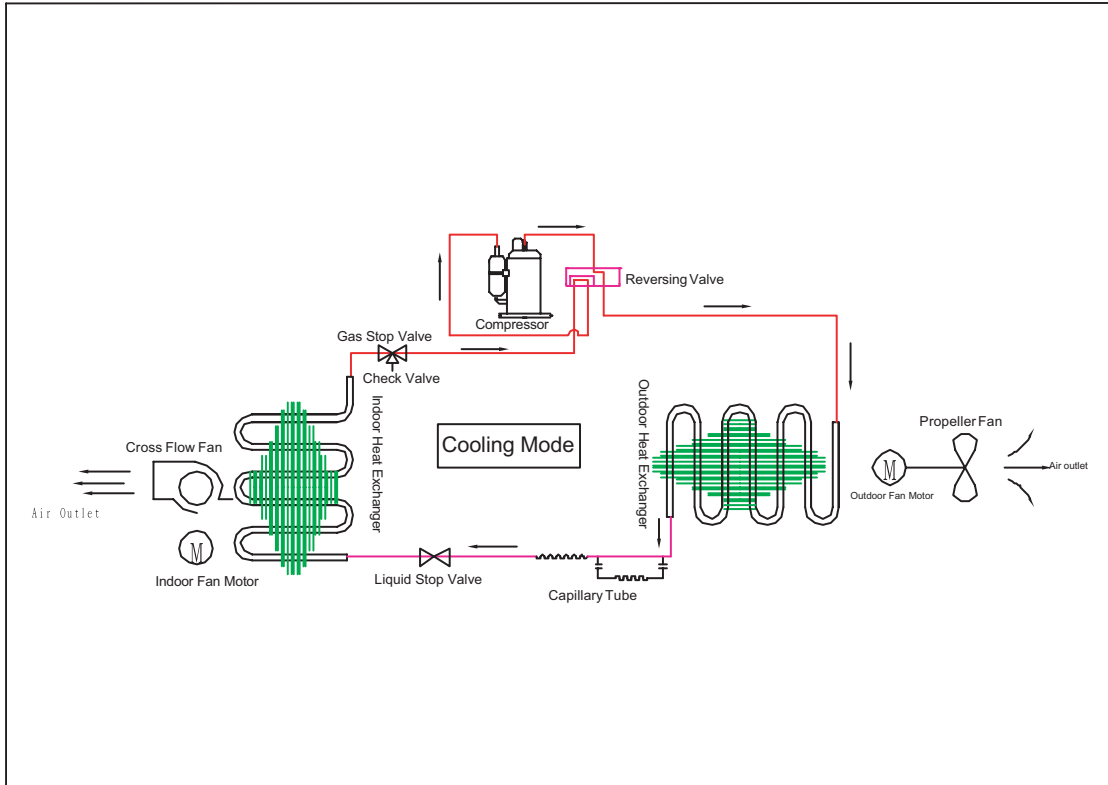

Heating mode

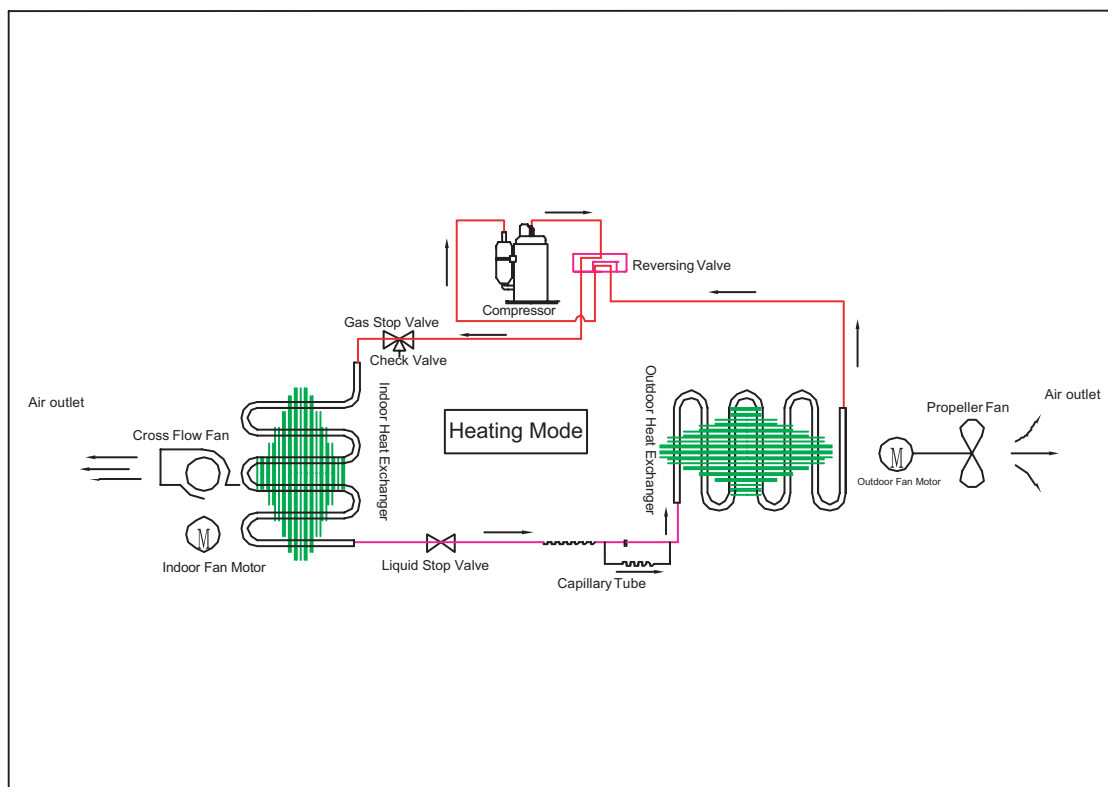

10.2 Wiring Diagrams

HSU-22LEA03

Indoor

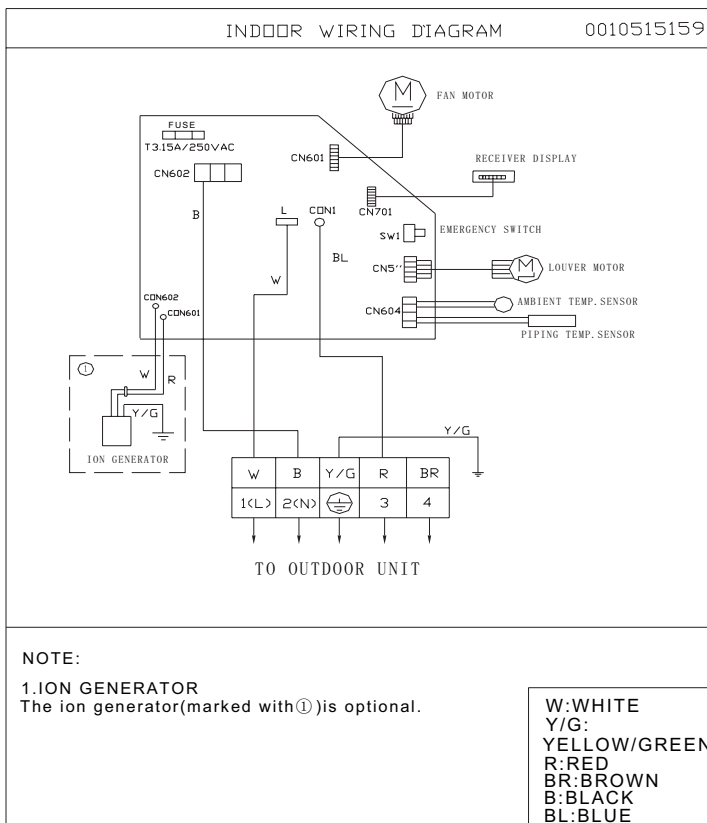

Outdoor

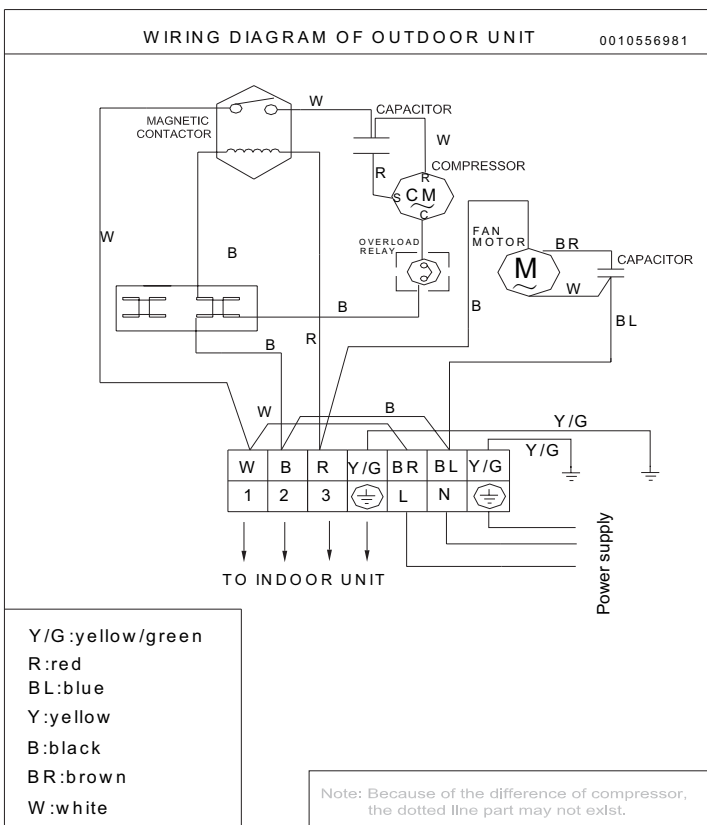

HSU-22HEA03

Indoor

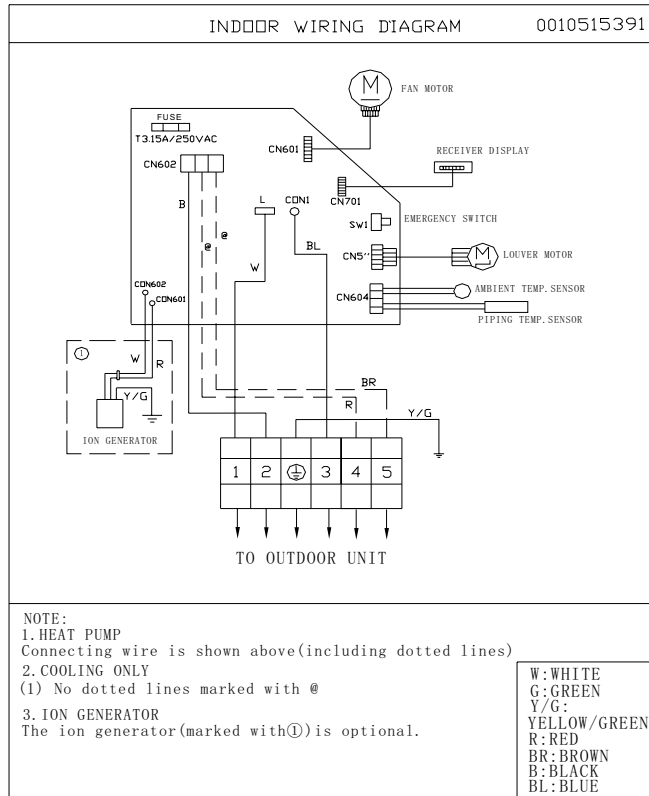

Outdoor

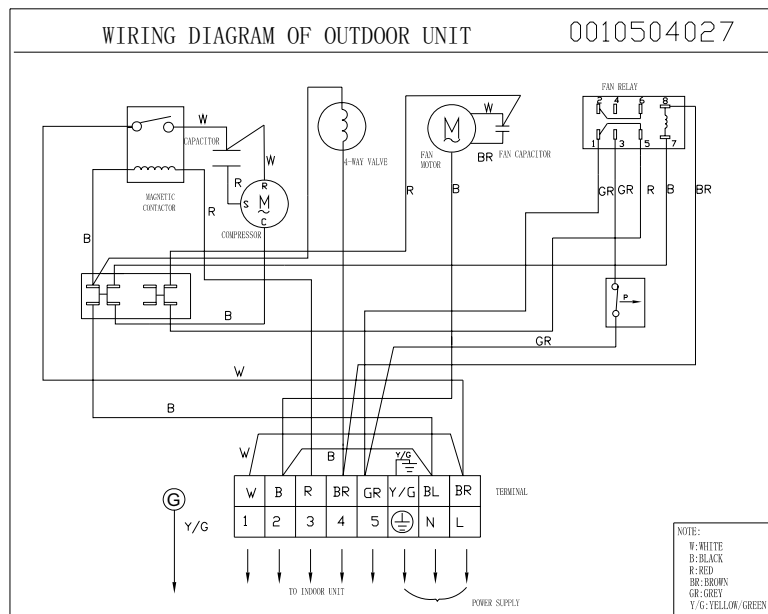

10.3 Circuit Diagrams

Control Panel 1

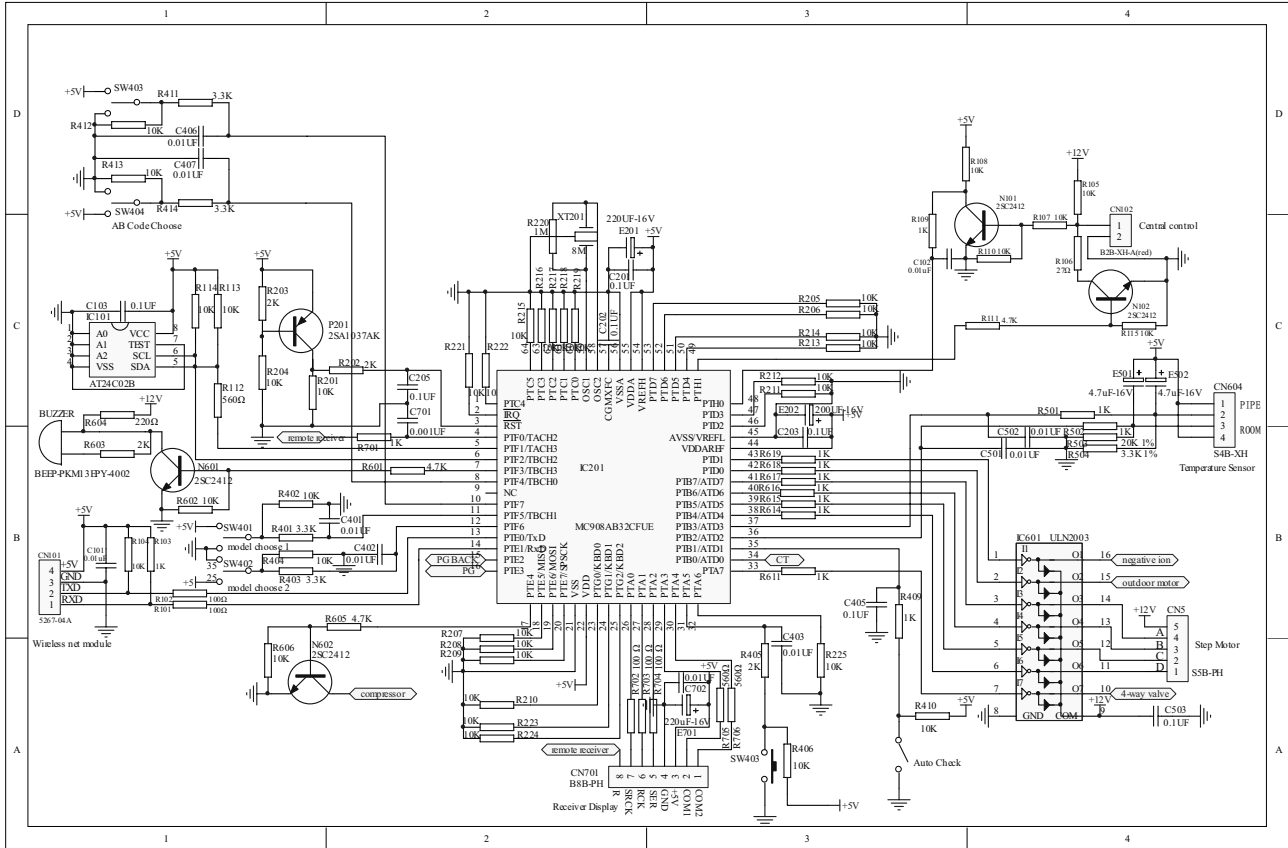

Control Panel 2

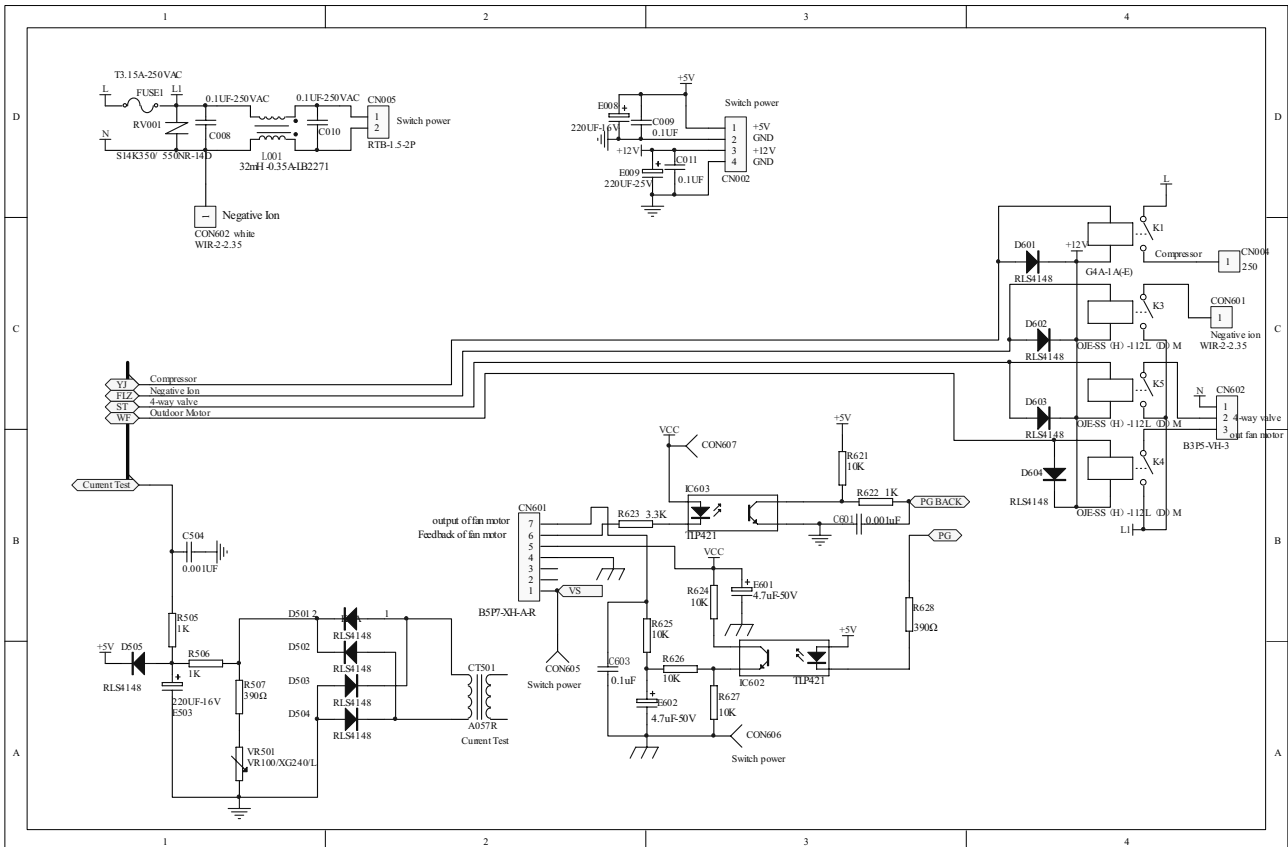

Switch power

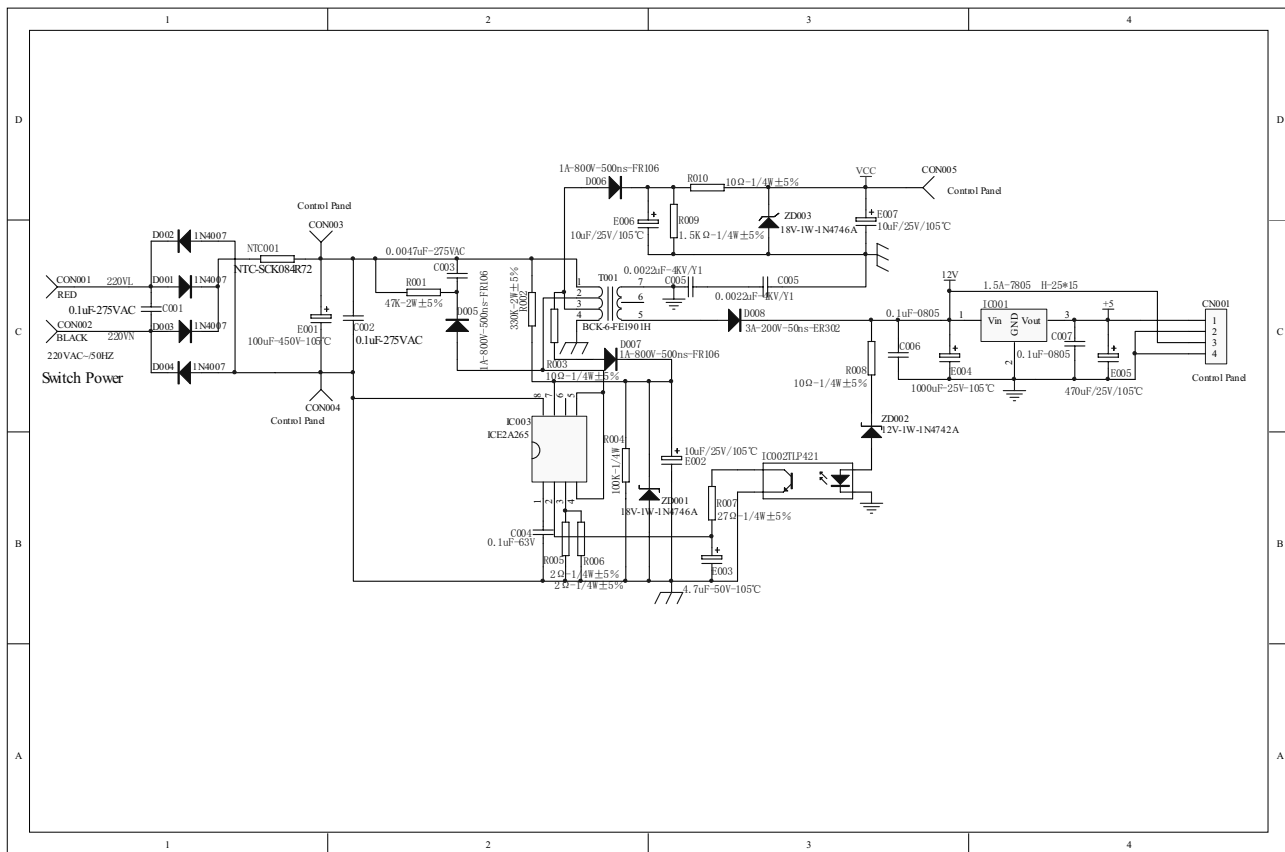

Sincere Forever

Haier Group

Haier Industrial Park, No.1, Haier Road
266101, Qingdao, China_

E-mail: hractech@haier.com

Tel: +86 532 87636957

[Http://www.haier.com](http://www.haier.com)

Edited by: Liu Xiujuan

Signed by: Yang Bifei

Approved by: Wu Hongjin



Большая библиотека технической документации

<https://splitsystema48.ru/instrukcii-po-ekspluatacii-kondicionerov.html>

каталоги, инструкции, сервисные мануалы, схемы.